



Suspension • Driveline • Chassis



Performance Urethane For All Cars & Trucks



PROTHANE™ was launched in 1991 when it acquired a little known manufacturer by the name of BC Engineering. At the time, BC offered less than 100 part numbers. But it's special formulations, precise engineering methods and attention to customer's needs caught our eye. Well the rest, as they say, is history and we now offer the most extensive line of urethane based performance products for cars and trucks on the planet. Whether it's an Asian or European import or any popular American car or truck, **PROTHANE™** has products for it.

Why Use Urethane?

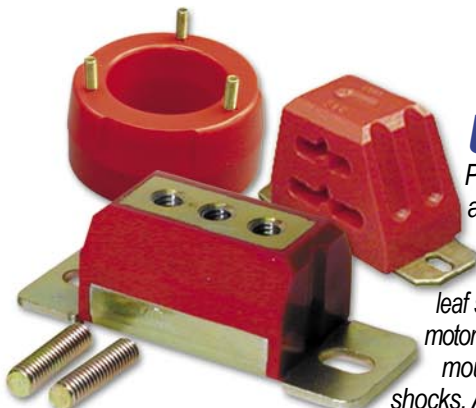

Production vehicles are built using rubber bushings in control arms, strut arms, leaf springs, body mounts, motor mounts, transmission mounts, sway bars and shocks. Additionally, rubber components can be found being used on coil spring pads, leaf spring pads and suspension bump stops. Not only are rubber components on the soft side to accommodate the typical car and truck buyer, they tend to deteriorate rapidly. This contributes to premature component failure, a "spongy" ride and less than ideal performance handling. Urethane can correct these conditions, while improving drivability.

Innovative Solutions



We have conquered many design challenges with some pretty cool innovations. Here are three examples: The first one was eliminating the need for grease fittings in many applications. We were the very first to use splined or grooved bores which holds in our very own **Super Grease™** guaranteeing you years of squeak free operation! Another is our super trick Motor Mount Inserts for front wheel drive "Import" cars. This unique approach lets the vehicle be driven either hard or easy without stock mount failure or any ride sacrifice. And lastly, incorporating the use of weight saving aluminum in our products. Trust **PROTHANE™** to always be researching better ways to enhance the performance of our products and your vehicle.

The Best Guarantee!

PROTHANE™ guarantees all it's urethane products to be free of defects in materials and workmanship (not due to abuse, neglect or misapplication) for the total time the vehicle remains with the original purchaser of the product(s). Should the products fail to meet these conditions, we will replace our product only, free of charge. This excludes any and all related labor charges. The product must be shipped to us (postage prepaid) along with a copy of the original receipt.

Colors

PROTHANE™ kits are stocked only in **RED** or **BLACK** polyurethane. **NOTE:** that all part numbers listed are for **RED** kits, if **BLACK** is desired, you must add the code **-BL** to the end of the part number. Other colors may be available by advanced special ordering only when quantity minimums and other requirements are met.



Designed To Fit

PROTHANE's design & engineering staff is dedicated to producing the highest quality urethane components on the market today. This goal is achieved through attention to detail, in house machining of master tools to exacting specifications and a genuine appreciation for true performance. With all aspects of design and development under one roof, our design team, R&D department and master machinists are able to provide our customers with higher quality parts that are designed to fit perfectly.



We've Got You Covered

Every **PROTHANE™** kit is backed by our technical staff which offers unsurpassed support for the life of the product. Each kit is shipped with complete and detailed instructions to insure proper installation the first time. In addition our staff will be happy to answer any questions you may have regarding the installation process as well as offer sound advice as to what product best suits your needs. Designed by car guys...backed by car guys...**PROTHANE™** We've got you covered.

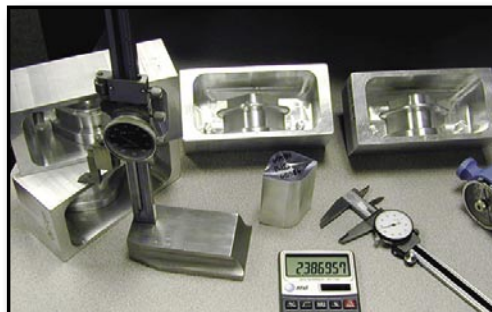

1-888-PROTHANE

Disclaimer

The use of recognized automotive manufacturers (i.e. Chevrolet) and their respective model names/numbers (i.e. Camaro, Z28) by **DEE ENGINEERING, Inc.** is for the sole purpose of application and description and in no way denotes their use to infer or intend a direct connection between **DEE ENGINEERING, Inc.** or **PROTHANE™** Products and those automobile manufacturers or factories.

Contents

Frequently Asked Questions	2
Featured New Products	3
Product Guide	4-7
Universal Products	8-10
Motor & Trans Mount Charts	11-15
Total Kit Charts	16-19
Acura	20
AMC	21
Austin	22
BMW	22
Buick	22-23
Cadillac	23
Chevrolet Beretta/Cavalier/Cobalt/Corsica	24
Chevrolet Camaro	24-25
Chevrolet Chevelle/EI Camino/Monte Carlo	25-26
Chevrolet Corvette	26-27
Chevrolet Full Size	27-28
Chevrolet Nova	28
Chevrolet Truck Full Size	29-32
Chevrolet Truck S-Series	32
Chrysler, Dodge/Plymouth	33-35
Dodge Truck	35-36
Ford Focus	37
Ford Mustang	37-38
Ford Compact/Mid/Full Size	38-39
Ford Thunderbird	39-40
Ford Truck Full Size	40-43
Ford Truck Ranger/Bronco II	44
Honda	45-46
Hyundai	47
International	47
Jaguar	47
Jeep®	48-50
Lexus	50
Lincoln/Mercury	51-52
Mazda	52
MG	53
Mitsubishi/Mitsubishi Truck	53-54
Nissan/Datsun	54-55
Nissan/Datsun Truck	55
Oldsmobile	56
Pontiac	57-59
Porsche	59
Rover	60
Saturn	60
Scion	60
Subaru	60
Suzuki	60
Toyota/Toyota Truck	61-63
Triumph	63
Volkswagen	64
Promotional	IBC

What Is Polyurethane?

Polyurethane is a term used to describe a wide ranging family of elastomers (any compound exhibiting the characteristics of natural rubber; stretchy and elastic). Poly meaning “many” and “urethane” the classification of the chemical structure. Polyurethane or urethane for short, is used as a solid cast material (bushings, mounts and mount inserts) and can be as soft as a rubber band or as hard as plastic.

How Are Urethanes Rated?

There are approximately 20 categories in which urethanes are rated based on physical properties. The most common is hardness. Others include: abrasion resistance, compression set, tensile strength, tear strength; etc. Ratings are not affected by the color.

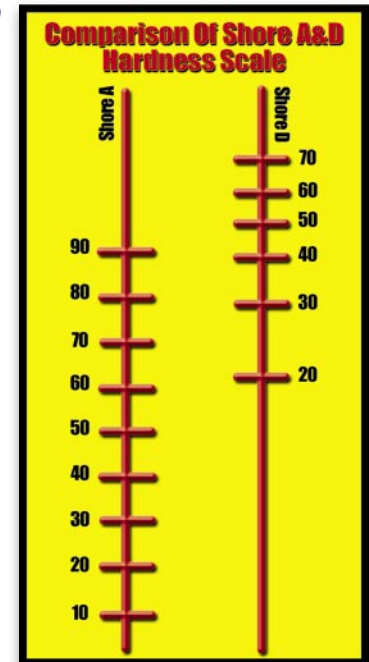

Will I Lose Ride Quality?

The original rubber bushing or mount was fairly soft which helped to attenuate noise and vibration that is generated by the tires and road surface. Increasing the hardness of the bushing either with harder rubber, urethane or even bronze, will allow more transmission of noise and vibrations. Some manufacturers formulate the hardness and design to reduce this effect. A softer urethane bushing allows the vehicle to perform better without the harshness, even over rubber components of the same hardness. The only change in ride quality is increased performance!

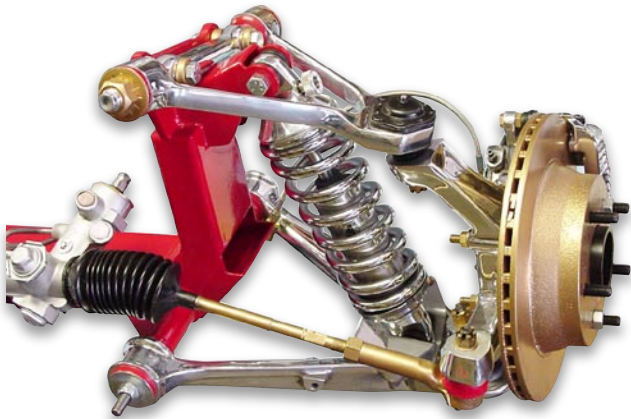

Do I Need Special Tools To Install?

No. Installing urethane components requires no special tools. However, if unique tools and equipment are required due to the type of vehicle, you will need them in order to do the job properly.

Will I Need To Reuse My Metal Shells?

PROTHANE™ has a complete shell program for most popular applications. Many of our control arm bushing kits come complete with a new shell. On some applications you will need to reuse the metal shell, so be very very careful when removing it from the vehicle. The shells themselves are not a replacement item. If you do damage a shell during the removal procedure, you have a few choices: Obtain a used piece from a repair shop or salvage yard or purchase a new shell with rubber bushings from your local parts store.



Typical Control Arm Bushings With Shells

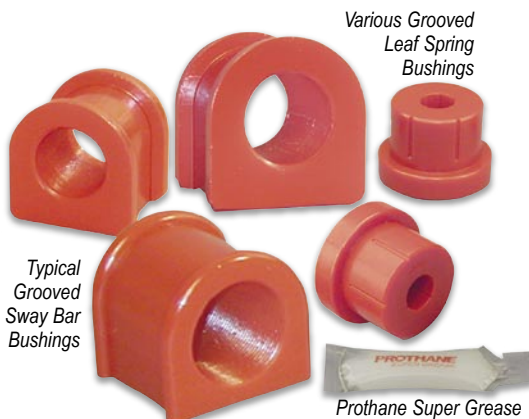

Various Grooved Leaf Spring Bushings

Typical Grooved Sway Bar Bushings

Prothane Super Grease

Does Urethane Squeak?

In a word, NO. Squeaking is caused by high frequency vibrations that can be heard rather than felt. It is usually caused by lack of lubrication, poor installation, incorrect part, or urethane that may be too hard for the application. In sway bar mount applications, most squeaking is the result of not cleaning the bar thoroughly prior to installation and failing to use our “squeak proof” Super Grease! Additionally, all of our dynamic application bushings feature grooves or splines designed to hold our grease (Included) providing even greater performance.



Mustang "Bullet" Motor Mounts

The most recent addition to our Mustang motor mount line are these "Bullet" motor mounts for both the 4.0L V6 and 4.6L V8 2005-06 Mustangs. They feature our revolutionary polyurethane compound sandwiched between stylish billet aluminum brackets. Giving you the strength that you need while shaving off weight over the original factory mounts.

(6-505)



Nissan 240SX Total Kit

This Total Kit is for the popular 95-98 Nissan 240SX. It contains front and rear control arm, end link and sway bar bushings. As well as bushings for the steering rack and front tension rods. An excellent solution for those who demand the ultimate suspension performance for drifting.

(14-2006)



Chevy Silverado 1500 2WD Total Kit

This 99-06 Total Kit continues our tradition of bringing you the latest complete applications for the full size Chevy pickups. It contains front control arm, end link and sway bar bushings, rear spring & shackle bushings and cab/body mounts with new steel washers.

(7-2042)

Chevy Cobalt Motor Mount Inserts

An inexpensive alternative and a stronger upgrade from the stock factory mounts. These sturdy one piece inserts completely replace the original rubber and include a replacement light-weight aluminum center sleeve. Available separately for either the front or rear transmission mounts of the 2005-06 Cobalt.

(7-516)



Early Mustang Front Bump Stops

Direct replacement for the original front rubber bump stops on 65-73 Mustangs. These specially formulated polyurethane replacements offer the proper rebound characteristics to help prevent the suspension from bottoming out under hard driving conditions. Complete with new steel washers and nylon lock nuts. Available in black only.

(6-1303-BL)

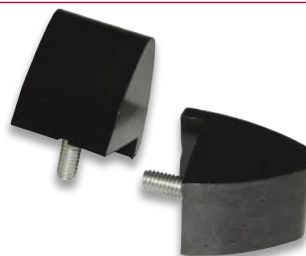

Here's the solution to a noisy problem. Undeniably, the most widely used jacks by serious off-roaders are made by Hi-Lift™*. But as you transverse around the back country the handle gets to bouncing and rattling. The simple solution to this problem is our Jack Grabber™ handle keeper. Unique design of the Jack Grabber™ eliminates the need to remove the top winch connector tab to install the handle keeper. Available in either red or our black urethane. (*Hi-Lift is a trademark of the Hi-Lift company).

(19-1404)



Super Grease™

Our Super Grease™ contains versatile water-proof, non-melting Teflon® and is formulated to seal out water and to lubricate under the most adverse conditions. It's superior adhesive and extreme pressure qualities, combined with it's urethane compatibility makes it the only one to use. One kit contains 3 tubes (approx. 1/2 oz. total)-enough to do any kit installation, while the other provides for numerous or complete vehicle applications.

Part No.	Description	Qty.
19-1750	Super Grease™	3 Tube Kit
19-1751	Super Grease™	14 oz. Tube



19-1751

Axle Pivot Bushings

PROTHANE'S special formulated Axle Pivot Bushings keep your Ford truck running straight and true. As Ford owners know, those heavy "I" Beams can quickly wear out the stock bushings. Tough enough for running off-road yet compliant enough for everyday street use.

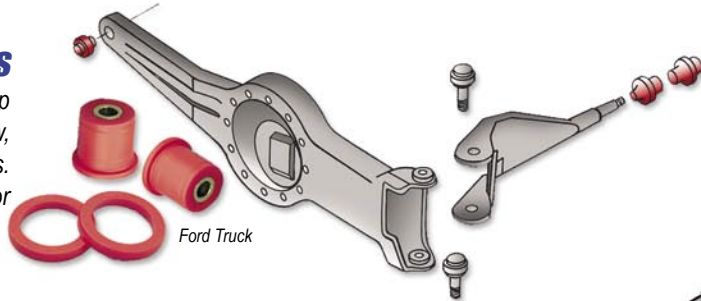

Ford Truck

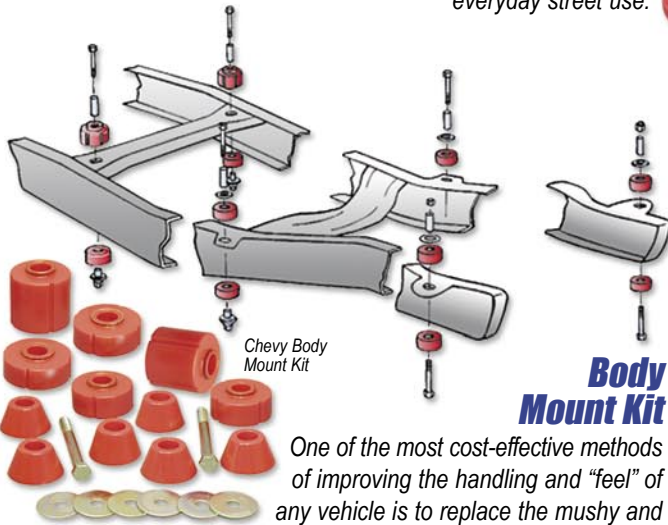

Chevy Body Mount Kit

Body Mount Kit

One of the most cost-effective methods of improving the handling and "feel" of any vehicle is to replace the mushy and probably worn-out OEM rubber body mount bushings.

PROTHANE™ body and cab mounts provide the necessary rigidity, yet have ample resilience to keep every thing quiet. Perfect for both off-road and street use.

Ball Joint Boots

The ball joint's smoothness of operation and service life are very much affected by dirt, moisture, and other contaminant's. For this reason, **PROTHANE™** ball joint boots are essential for protecting this important suspension component. Take your pick of black, or red colored boots.

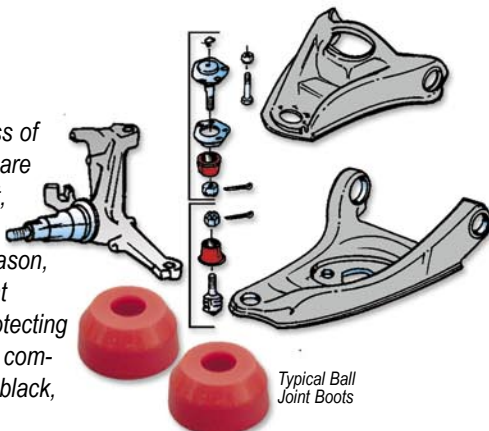

Typical Ball Joint Boots

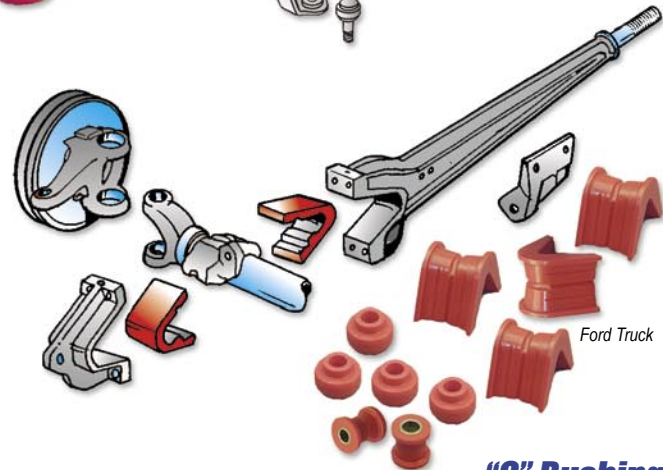

Ford Truck

"C" Bushings

PROTHANE™ provides you with additional opportunities to "snug up" your suspension with heavy duty "C" bushings for use in the "jaws" of Ford strut arms. These components help provide a responsive, stable ride and eliminate the "wandering" associated with worn stock bushings. Different degrees are available for varying ride heights.

Coil Spring Lift Spacers

An inexpensive alternative to costly suspension lift kits. These coil spring lift spacers allow your vehicle to be raised up to 2 inches while still using your stock coil springs. Available for Dodge, Ford, Jeep, Toyota, and GM vehicles.



Control Arm Bushings, Front

You can imagine how difficult it is to maintain the proper front suspension caster and camber when the control arms are wobbling on mushy rubber bushings. **PROTHANE'S** design provides superior handling through optimum compliance resistance. Furthermore, you can be assured that your alignment settings will be accurately maintained.

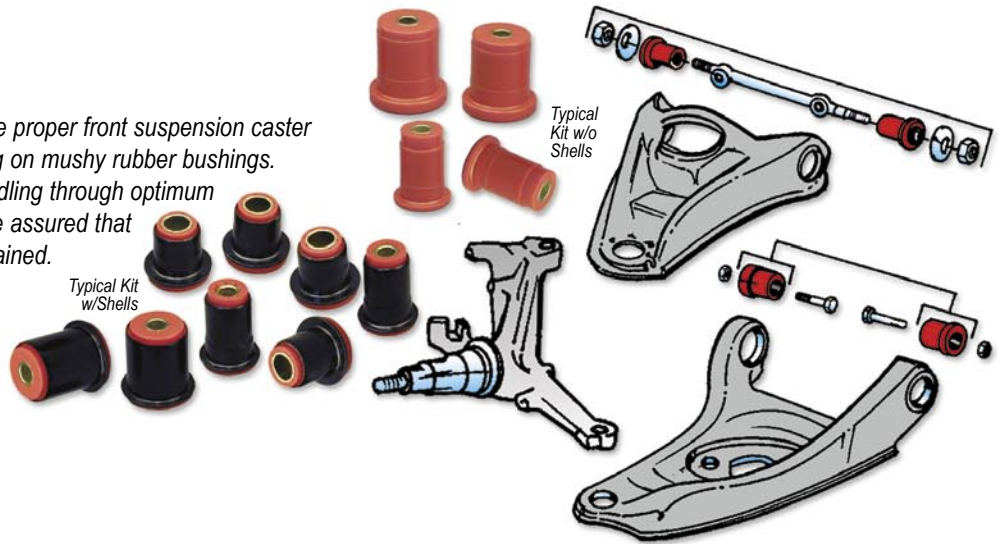

Drive Train

Helping to keep the driveline properly aligned is an important benefit of **PROTHANE™** polyurethane bushings. Factory bushings tend to wear out, with the resultant sloppiness putting the driveline in a potential "bind" condition. Controlling horsepower benefits acceleration and handling.

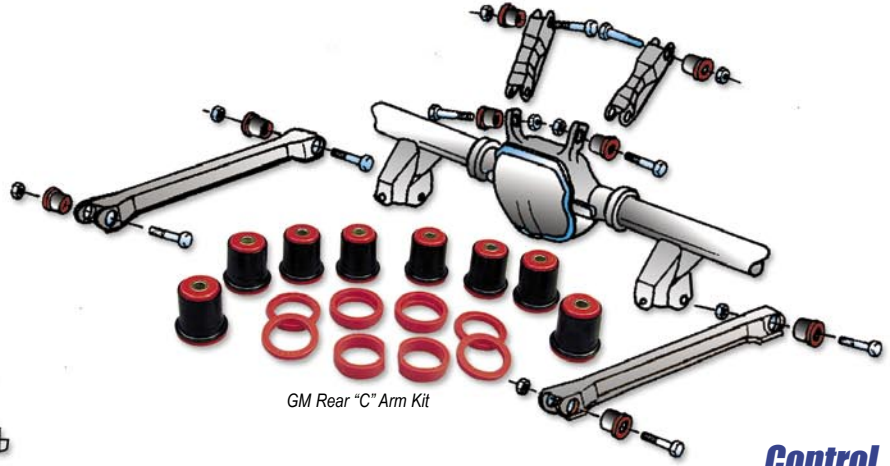
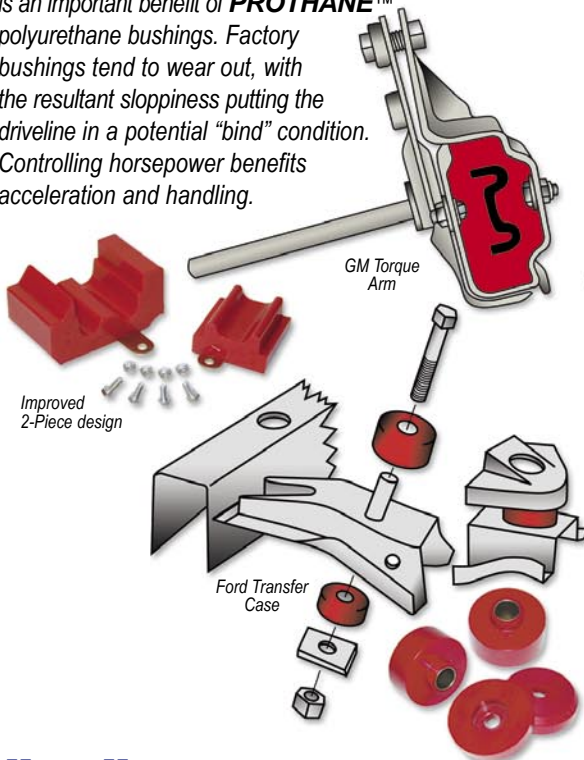

Control Arm Bushings, Rear

A vital addition to any vehicle. Controls unwanted hop or shudder. **PROTHANE™** offers complete kits for all popular rear two and four arm applications. We offer a selection of both shelled and unshelled versions.

Motor Mounts

We offer a wide variety of motor mount styles. In all cases, our mounts are designed to limit the travel, reduce the chance of breakage and put the power to the wheels. All of our Motor Mount Kits feature application specific engineering. In other words, they are not universal in fit and provide you with the performance you demand. If applicable, our mounts feature a Poly-Locked "run-safe" feature just in case you play way too hard...so you can still get back home.

Check the easy to use Motor Mount & Trans Mount charts starting on page 11, for the specific application of each Motor Mount and Trans Mount Kit.

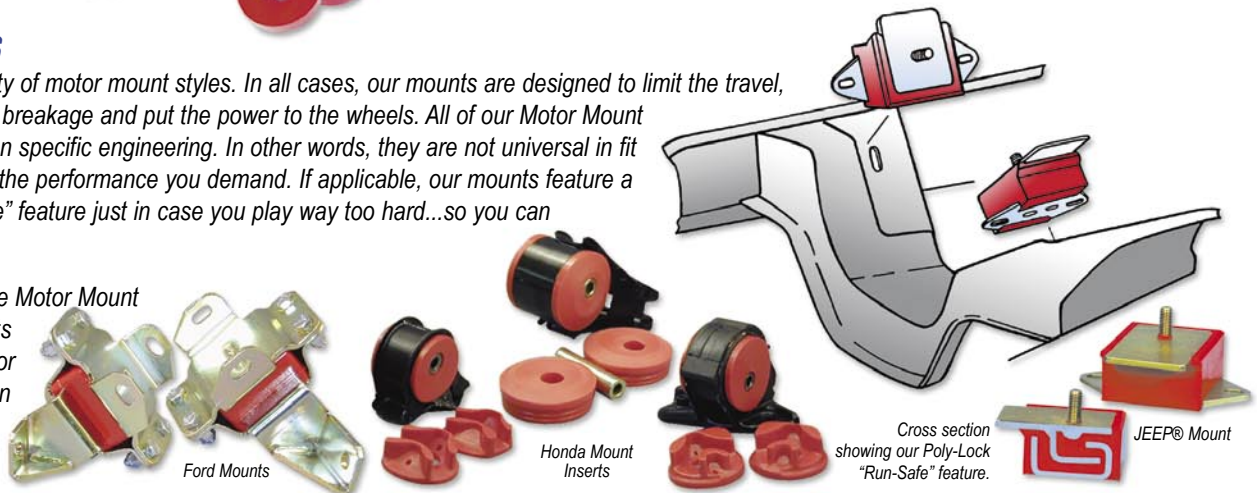

Radiator Isolators

With four models to choose from, these four piece isolator kits for the 1968-81 GM Cars, and 1973-98 GM/GMC Trucks, and Sport Utility Vehicles cover both small block and big block engine vehicles. PROTHANE's revolutionary polyurethane compound makes these isolator mount kits impervious to chemicals and elements unlike the stock rubber units.

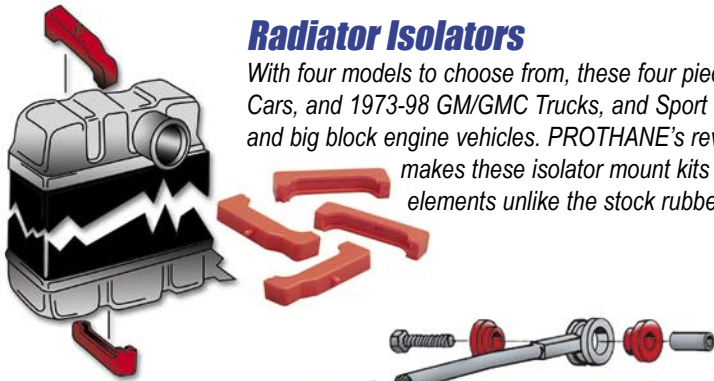

Shifter Bushings

One of the sloppiest items on front drive cars can be the shifter. This is especially true if the car is getting older or has been shifted hard. Our bushings firm up your linkage while providing you with added confidence during power shifts. A very inexpensive performance enhancer!

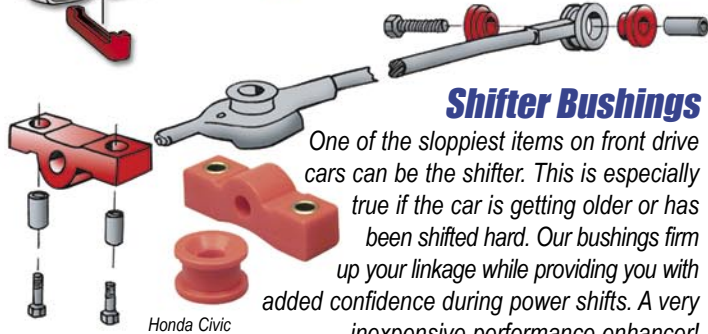

Spring Isolators, Coil Type

Models to fit most GM applications and most Mustangs. Solves the common problem of worn or rotted OEM rubber pads. Reduces noise and looks great! Check the vehicle listings section for specific applications.



Spring Isolators, Leaf Style

We have applications for all the GM rear leaf type suspensions. Replaces those inferior OEM pads. A must when rebuilding the suspension or changing the rear springs. Check listings for specific applications

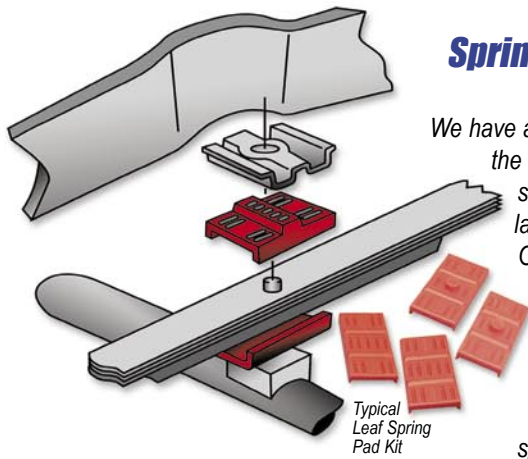

Spring & Shackle Bushings

In leaf spring-type suspensions there are significant forces focused on the pivot points and shackles. For this reason, it is imperative to replace the soft, blown-out OEM rubber bushings with PROTHANE™ premium grade polyurethane components. All related sleeves, etc.. are precision fabricated to assure a perfect fit.

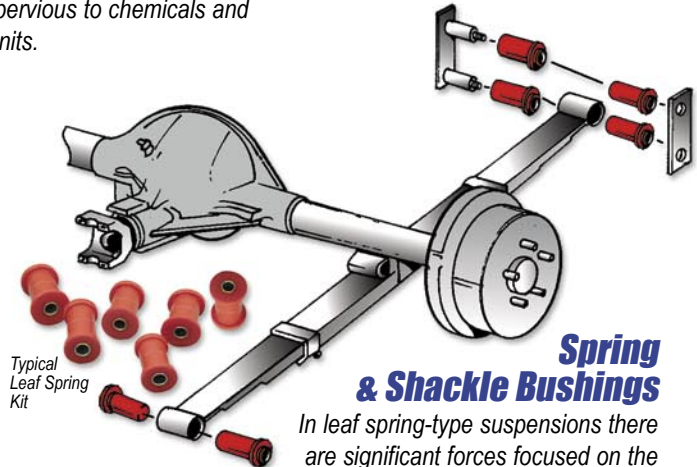

Heavy Duty Spring Shackle Bushing Kits

We now offer complete Heavy Duty Shackle Bushing Kits for Camaro's and Mustang's.

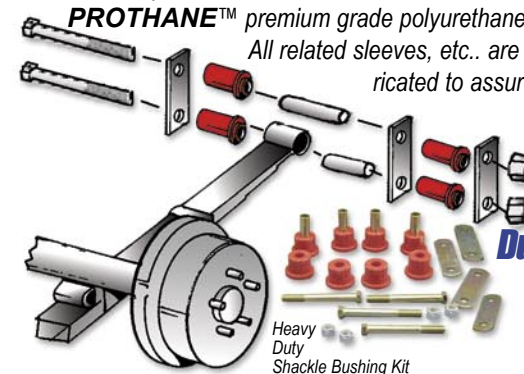

Steering Bushings

PROTHANE™ offers high performance steering components that will last longer and improve chassis feedback. From rack & pinion to worm gear boxes, we have a variety of applications. While most models are direct factory replacements, we also offer various rack & pinion "offset" versions for those with modified ride height.

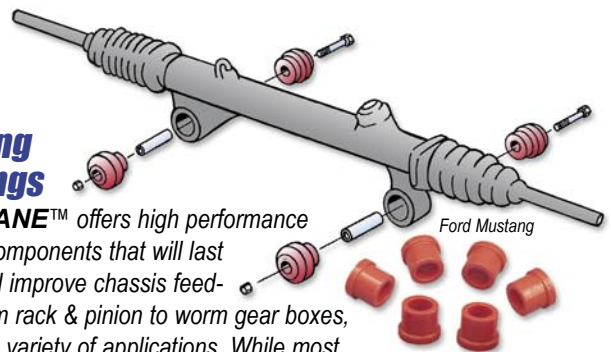

Strut Arm/Rod Bushings

Rapid acceleration and hard braking place varying loads on the suspension, and in some applications strut rods are employed to maintain proper alignment. **PROTHANE'S** durable, responsive polyurethane bushings are far superior to the OEM rubber components or parts, which typically have deteriorated.

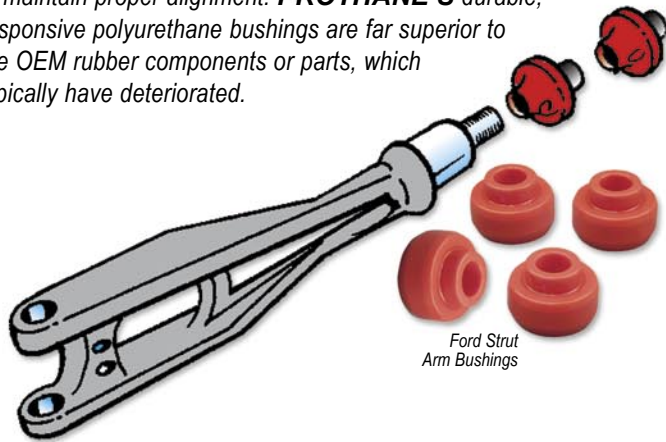

Ford Strut Arm Bushings

Track Arm/Panhard Rod Bushings

Get rid of that annoying sway after installing these bushings into your vehicle's Track Arm or Panhard Rod. Specifically formulated to control any unwanted motion in the front or rear of today's straight axle vehicles. A must for any heavy application or race vehicle.

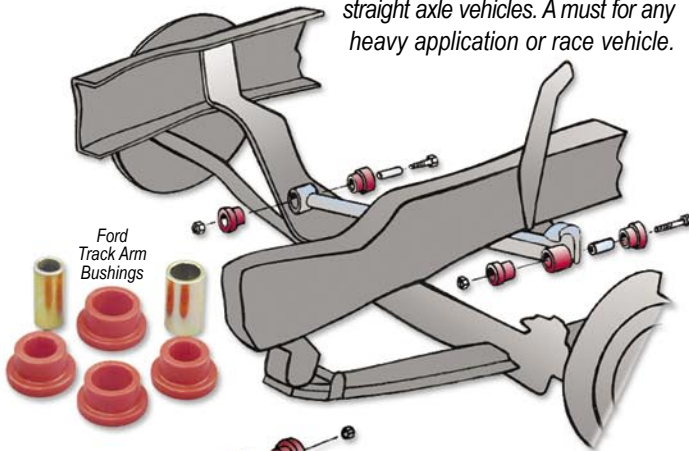

Ford Track Arm Bushings

GM Panhard Bushing Kit

Ford Trans. Kit

Sway Bar & End Link Bushings

The effectiveness of OEM stabilizer (anti-roll or sway) bars can easily be enhanced through replacing the mushy stock rubber bushings with firm **PROTHANE™** polyurethane bushings. They feature grooved bores, designed to hold **PROTHANE'S** Super Grease, for quiet operation. Also available for larger diameter high performance sway bars.

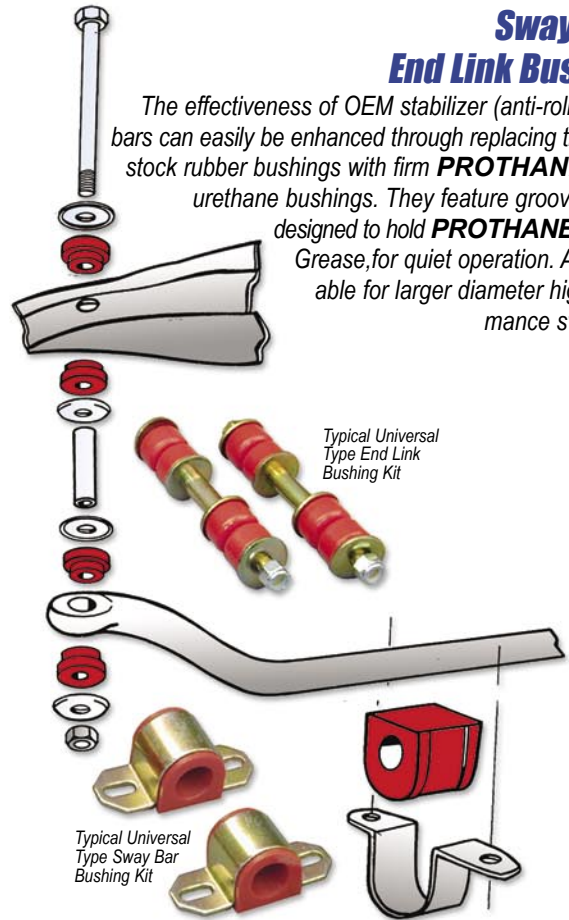

Typical Universal Type End Link Bushing Kit

Typical Universal Type Sway Bar Bushing Kit

Transmission Mounts

Factory rubber mounts were never intended to take much abuse, so the resultant sloppiness in your drivetrain can be largely traced to the Transmission Mounts. Our mounts are designed to control torque and eliminate breakage. Where applicable, our mounts feature our Poly-Locked "run-safe" interlocking device so you'll never be left stranded like a broken stock mount will.

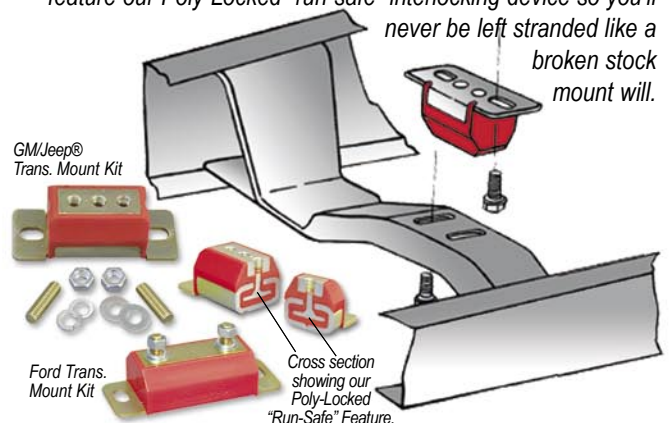

GM/Jeep® Trans. Mount Kit

Ford Trans. Mount Kit

Cross section showing our Poly-Locked "Run-Safe" Feature.

Universal Sway Bar Bushings

PROTHANE™ offers precision-made, yet universal, sway bar bushing sets that deliver maximum performance. The same formulated performance compound found in our other sway bar bushings is used here, giving you superior handling over the stock rubber units. The widest range available to cover all popular applications. Each pair is sold with matching heavy duty brackets to insure a perfect fit, see diagram below for the bracket style that best suits your needs.

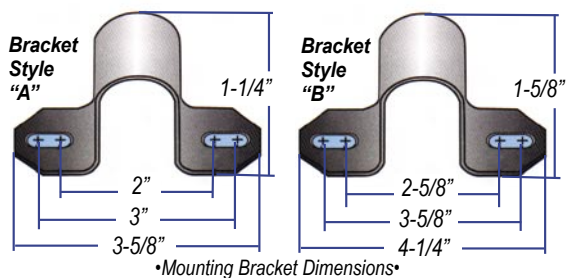

BAR DIAMETER	BRACKET STYLE "A"	BRACKET STYLE "B"	BAR DIAMETER	BRACKET STYLE "A"	BRACKET STYLE "B"
7/16"	19-1101	19-1125	16mm	19-1115	
1/2"	19-1102	19-1126	17mm	19-1116	
9/16"	19-1103	19-1127	18mm	19-1117	
5/8"	19-1104	19-1128	19mm	19-1118	
11/16"	19-1105	19-1129	20mm	19-1119	
3/4"	19-1106	19-1130	21mm	19-1120	
13/16"	19-1107	19-1131	22mm	19-1121	
7/8"	19-1108	19-1132	23mm	19-1122	
15/16"	19-1109	19-1133	24mm	19-1123	
1"	19-1110	19-1134	25mm	19-1124	19-1141
1 1/16"		19-1135	26mm		19-1142
1 1/8"		19-1136	27mm		19-1143
1 1/4"		19-1137	28mm		19-1144
1 5/16"		19-1138	29mm		19-1145
			30mm		19-1146
			31mm		19-1147
			32mm		19-1148

PART #	"A" LENGTH	PART #	"A" LENGTH
19-401	2 3/8"	19-412	4 3/4"
19-402	3"	19-413	5 3/8"
19-403	2 5/8"	19-416	5"
19-404	3 3/4"	19-417	6 1/8"
19-405	3 1/4"	19-419	7 3/8"
19-406	3 1/2"	19-420	1 3/8"
19-408	4 1/4"	19-421	2 3/4"
19-409	4 1/2"	19-424	4 5/8"

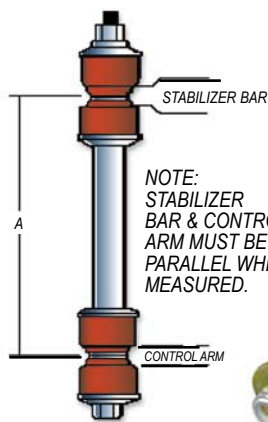

End Link Bushing Kits

PROTHANE™ If your vehicle uses standard length end links, use this guide to find the correct kit. With the car level (not jacked up), check to make sure stabilizer bar and control arm are parallel (B and C). Now, measure distance "A" (front center of stabilizer bar to control arm) and compare length to application chart to find your end links and part number.

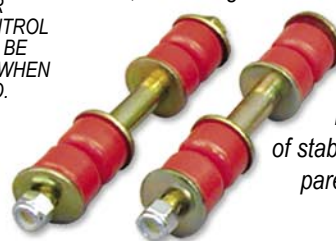

End Link Bushings Only

These End Link Bushings Only kits are designed for those who don't feel the need to upgrade all their existing OEM hardware but would like the enhanced performance that only urethane offers.

We also offer one kit with washers. Measure your vehicle to determine which kit best suits your needs.

PART NO.	DESCRIPTION	PER SET
19-426	Full Size Truck Style, 3/4" X 1 1/4" O.D.	Set Of 4
19-427	Cars And Mini Trucks 1/2" X 1" O.D.	Set Of 8
19-428	Cars And Mini Trucks, 5/8" X 1" O.D.	Set Of 8
19-429	Cars And Mini Trucks, 3/4" X 1" O.D.	Set Of 8
19-430	HD Set With Washers, 5/8" X 1 1/8" O.D.	Set Of 8

PART NO.	TYPE	DESCRIPTION	PER SET
19-1315	A	11/16" x 1 5/8" (Small Button)	2
19-1316	B	11/16" x 2" (Large Button)	2
19-1317	C	1 9/16" x 1 5/8" (Cone-Type)	2
19-1318	D	2 1/4" x 2 1/4" (Cone-Type With Steps)	2
19-1319	E	3/8" x 2" (Ultra-Thin)	2
19-1320	F	7/8" x 2 1/4" (Hex Shape)	2
19-1301	G	7/8" x 1 7/8" x 1 3/8" (Rectangular)	2
19-1302	H	1" x 1 3/4" x 1 7/16" (Curved Top)	2
19-1303	I	1 3/8" x 1 1/8" x 1 1/4" (Wedge)	2
19-1304	J	5/8" x 2" x 2" (Small Square)	2
19-1305	K	2" x 2" x 2" (Large Square)	2
1-1301	L	1 3/4" x 3" x 1 3/4" (Rectangle, Wedge)	2
19-1312	M	1 1/2" x 2" x 1 3/4" (Wedge)	2

Bump Stops (Cone & Button Style)

PROTHANE™ offers a comprehensive selection of cone and button style bump stops, designed to accommodate your specific vehicle's needs.

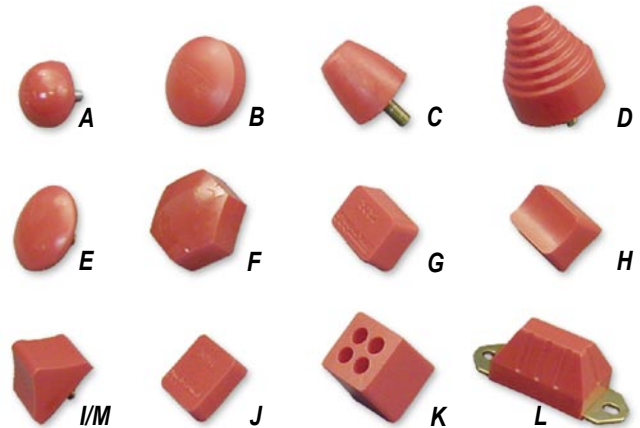

Bump Stops (Progressive)

PROTHANE™ specially formulated, multi-mount progressive rate suspension stops prevent the damage caused when a suspension bottoms out. Add the energy absorption capabilities of polyurethane to the unique progressive chambers molded into the stops and you've got progressive compression rate bump stops. The multi-mount feature ensures quick, easy retrofitting, as one of the mounting systems will be ideal for your particular application. Using a unique poly-lock system, the polyurethane portion and mounting bracket are integrated into one rugged, versatile component.

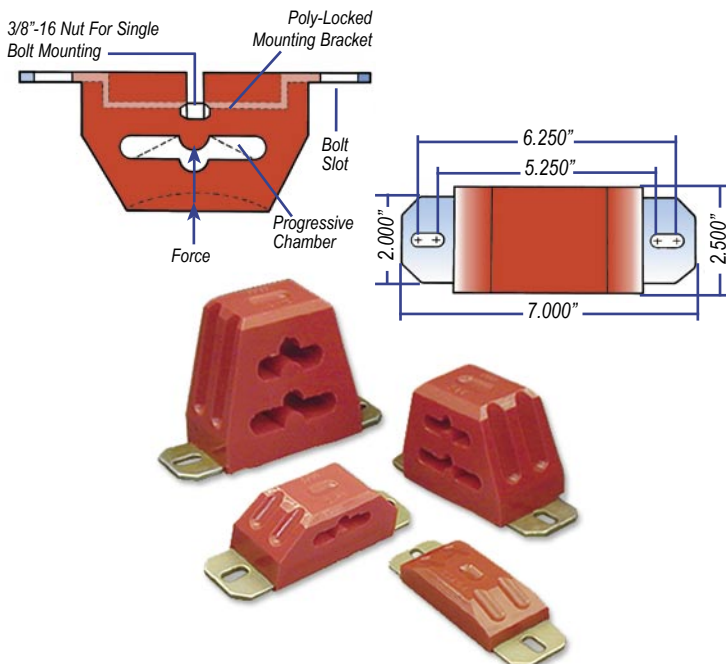

PART NO.	DESCRIPTION	PER SET
19-1314	Suspension Bump Stop 1" Multi-Mount	2
19-1306	Suspension Bump Stop 2" Multi-Mount	2
19-1307	Suspension Bump Stop 2 1/2" Multi-Mount	2
19-1308	Suspension Bump Stop 3" Multi-Mount	2
19-1309	Suspension Bump Stop 3 1/2" Multi-Mount	2
19-1310	Suspension Bump Stop 4" Multi-Mount	2
19-1311	Suspension Bump Stop 4 1/2" Multi-Mount	2

Coil Spring Inserts

PROTHANE™ Coil Spring Dampening Inserts are available in five (5) heights, so stacking is a practice of the past. These inserts prevent suspension bottoming and add a progressive compression rate to coil springs.

Dampening inserts, when installed should be from 1 to 3 inches less in

height than the springs installed height on Chevrolet vehicles, 3/4 to 1 1/2 inches less for Dodge vehicles, and 2 to 3 inches less for Ford vehicles. Specially formulated non-rebound polyurethane inserts offer yet another aspect to your suspension tuning by eliminating the amount of rebound after compression.

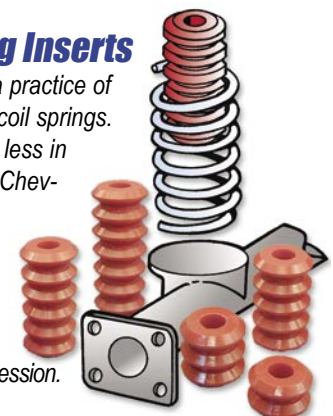

PART NO.	DESCRIPTION	PER SET
19-1701	Coil Spring Insert (2 Ring) 2 1/2" High X 3 3/4" O.D.	2
19-1702	Coil Spring Insert (3 Ring) 3 1/2" High X 3 3/4" O.D.	2
19-1703	Coil Spring Insert (4 Ring) 5" High X 3 3/4" O.D.	2
19-1704	Coil Spring Insert (6 Ring) 7 1/2" High X 3 3/4" O.D.	2
19-1705	Coil Spring Insert (8 Ring) 10 1/2" High X 3 3/4" O.D.	2



Pivot Bushings

PROTHANE™ Pivot Bushing Kits fit most common 4-bar systems, yet offers a multitude of universal applications. Each set includes 4 bushings and 2 sleeves.

STEM TYPE

PART #	A	B	C	D	E	F
19-901	.860"	.375"	1.270"	.600"	1.20"	
19-902	.600"	.375"	1.270"	.630"	1.20"	
19-921	.600"	.375"	1.270"	.630"	1.20"	

1 PIECE HOURGLASS

19-903	1.010"	.625"	1.140"	.990"	1.470"	
19-904	1.010"	.750"	1.140"	.990"	1.470"	
19-905	1.285"	.688"	1.480"	1.125"	1.580"	
19-906	1.285"	.750"	1.480"	1.125"	1.580"	

1 PIECE STRAIGHT (HAT)

19-907	1.285"	.625"	1.450"	.720"	1.565"	.423"
19-908	1.285"	.750"	1.450"	.720"	1.565"	.423"
19-909	1.090"	.625"	1.240"	.920"	1.400"	.240"

2 PIECE HOURGLASS

19-915	1.050"	.630"	1.460"	.680"	1.050"	
19-916	1.035"	.750"	1.910"	.830"	1.040"	
19-917	1.295"	.695"	1.470"	.800"	1.290"	
19-918	1.310"	.750"	1.489"	.800"	1.280"	

2 PIECE STRAIGHT (HAT) w/SLEEVE

19-919	1.030"	.500"	1.340"	.630"	1.620"	.500"
19-920	1.030"	12mm	1.340"	.630"	1.620"	.500"

PART #	TUBE LENGTH	BUSHING O.D.	SLEEVE LENGTH	BOLT SIZE
19-601	1"	1 1/8"	1 27/64"	1/2"
19-602	1"	1 1/8"	1 27/64"	9/16"
19-603	1 1/4"	1 1/4"	1 3/4"	1/2"
19-604	1 1/4"	1 1/4"	1 3/4"	9/16"
19-605*	2"	1 1/2"	2 1/2"	1/2"
19-606*	2"	1 1/2"	2 1/2"	9/16"
19-607*	2 1/2"	1 1/2"	3"	1/2"
19-608*	2 1/2"	1 1/2"	3"	9/16"

*Recommended Tubing: 1 3/4" X .125", 1 7/8 X .187", 2" X.250"

Shock Mount Bushings

Upgrade your new shock absorbers or breathe new life into your old ones with these **PROTHANE™** shock mounts, eyes & grommets.

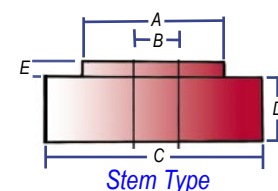
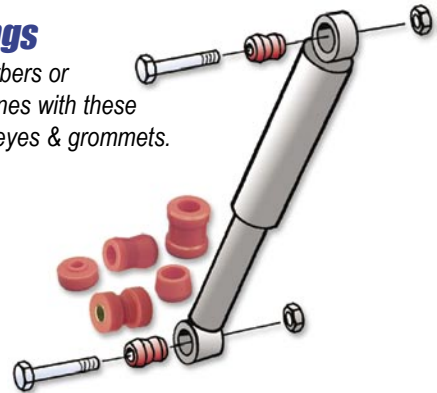
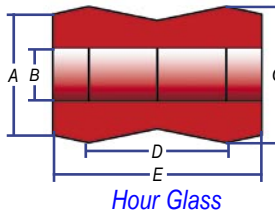
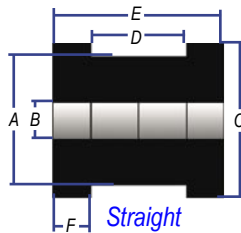

Shock Reservoir Mounts

These Shock Reservoir Mounts provide a dampening effect in between the remote shock absorber reservoir and the mounting tube. Available in various sizes from 1.500 to 3.000 " to accommodate all popular tube sizes.

PART No.	"A"	"B"
19-1711	.472"	1.200"
19-1712	.590"	1.375"
19-1713	.550"	1.438"
19-1714	.650"	1.625"

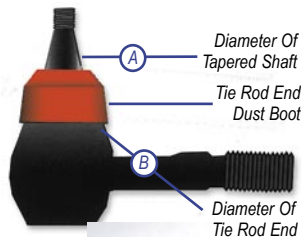

PART No.	DIA. 1	DIA. 2
19-1718	1.5"	2"
19-1719	1.5"	2.5"
19-1720	1.5"	3"
19-1721	2"	2"
19-1722	2.5"	2.5"

Urethane Jack Pads™

Help protect your tricked-out chassis from "jack assault" with these trick Jackpads™. You've spent a lot of time and money painting and detailing your chassis and drive line. Don't allow your jack to destroy your efforts. Specially formulated soft urethane pad simply fits over the top of your jack or jack stand.



PART NO.	DESCRIPTION
19-1403	Jackpad™, Fits Up To 3" Diameter Jack
19-1401	Jackpad™, Fits Up To 7 1/4" Diameter Jack
19-1402	Jackpad™, Fits Up to 9" Diameter Jack
19-1411	Jack Stand Pads, Fits Up To 2 1/2" X 4 1/2" Heads
19-1412	Jack Stand Pads, Fits Up To 1 1/4" X 4 1/2" Heads
19-1413	Jack Stand Pads, Fits Up To 1-1/2" X 6" Heads

*Due to the many sizes and styles of jacks and jack stands available, select the size that best fits your application.





Sport Compact Motor & Transmission Mount Inserts

(All inserts are designed for manual transmission cars, unless specified)



Model	Year	Left Mount	Right Mount	Rear Mount	Front Mount	All Mount Combo Kits
-------	------	------------	-------------	------------	-------------	----------------------

ACURA

Integra (GS, LS, RS)	90-91	8-510	8-511	8-512	N/A	8-1905
Integra (GS, LS, RS)	92-93	8-516	8-511	8-512	N/A	8-1908
Integra (GSR)	92-93	8-510	8-511	8-512	N/A	8-1905
Integra	94-01	8-501	8-502	8-509	N/A	8-1904

Model	Year	Upper Mount	Lower Torque Strut	Front Trans. Mount	Rear Trans. Mount	All Mount Combo Kits
-------	------	-------------	--------------------	--------------------	-------------------	----------------------

CHEVROLET

Cavalier (Non Ecotec)	95-04	7-513*	7-511*	7-514**	7-515**	N/A
Cobalt 2.0 S.C.	05-07	N/A	N/A	7-516**	7-516**	N/A
Cobalt 2.2/2.4	05-07	N/A	N/A	7-517**	7-517**	N/A

*5-Speed & Automatic / **Manual Only

Model	Year	Left Mount	Right Mount	Rear Mount	Front Mount	All Mount Combo Kits
-------	------	------------	-------------	------------	-------------	----------------------

CHRYSLER / DODGE / PLYMOUTH

Neon (Race)	95-99	4-503	4-502	N/A	4-501	4-1901
Neon (Street)	95-99	—	—	N/A	—	4-1902
Neon (Race)	00-06	N/A	—	N/A	—	4-1905*
Neon (Street)	00-06	N/A	—	N/A	—	4-1906*

*Passenger Side Upper & Lower Mount Inserts & Washers

FORD

Focus	00-06	N/A	N/A	N/A	6-502*	N/A
-------	-------	-----	-----	-----	--------	-----

*Front Lower Mount

Model	Year	Left Mount	Right Mount	Rear Mount	Front Mount	All Mount Combo Kits
-------	------	------------	-------------	------------	-------------	----------------------

HONDA

Accord	90-97	N/A	N/A	8-514	N/A	N/A
Accord	94-97	N/A	N/A	8-514	8-515	8-1907
Civic/CRX	88-91	8-506	8-507	8-508	8-517	8-1903
Civic/Del Sol*	92-95	8-501†	8-502	8-503	N/A	8-1901†
Civic	96-00	8-504	8-505	8-503	N/A	8-1902
Civic SI	99-00	8-504	8-505	8-509	N/A	8-1906

*Excluding 92-93 SI †1.6L Only

HYUNDAI

Tiburon V6	03-05	N/A	N/A	28-501	28-501	N/A
------------	-------	-----	-----	--------	--------	-----

MITSUBISHI

Model	Year	Upper Mount	Lower Torque Strut	Front Trans. Mount	Rear Trans. Mount	All Mount Combo Kits
Eclipse / Laser / Talon, FWD-AWD-Turbo-Non Turbo						
	90-94	13-503	13-501	13-506	13-505	13-1902
Eclipse / Talon, FWD-AWD-Turbo-Non Turbo						
	95-99	13-503	13-501	13-504	13-502	13-1901
Eclipse 4-Cyl.	00-05	13-509	13-503	13-510	13-507	13-1904
Eclipse V6	00-05	13-509	13-503	13-508	13-507	13-1903

Model	Year	Upper Mount	Lower Torque Strut	Front Trans. Mount	Rear Trans. Mount	All Mount Combo Kits
-------	------	-------------	--------------------	--------------------	-------------------	----------------------

PONTIAC

Sunfire (Non Ecotec)	95-04	7-513*	7-511*	7-514**	7-515**	N/A
----------------------	-------	--------	--------	---------	---------	-----

*5-Speed & Automatic / **Manual Only

Model	Year	Upper Mount	Lower Torque Strut	Front Torque Struts	Rear Trans. Mount	All Mount Combo Kits
-------	------	-------------	--------------------	---------------------	-------------------	----------------------

SATURN

S-Car	92-00	N/A	N/A	7-510	N/A	N/A
-------	-------	-----	-----	-------	-----	-----

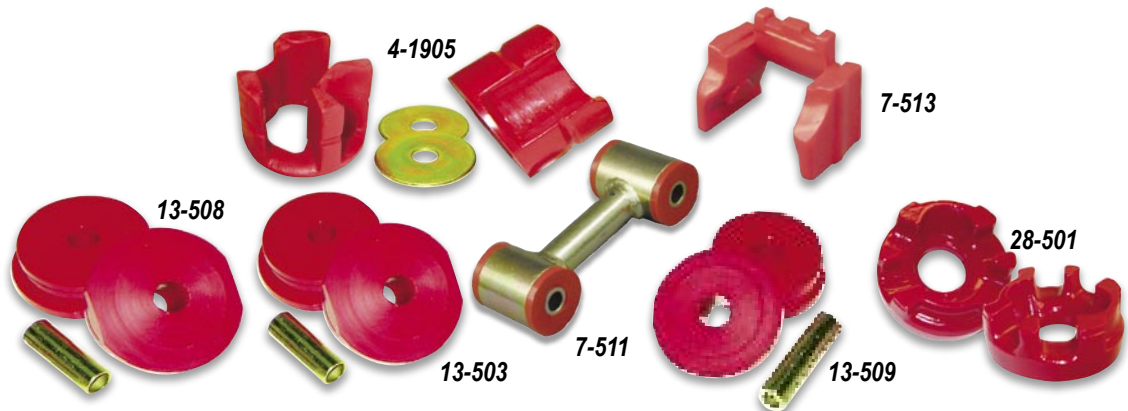

Motor & Transmission Mount Charts

Specific Applications



Domestic Vehicle Motor & Transmission Mounts

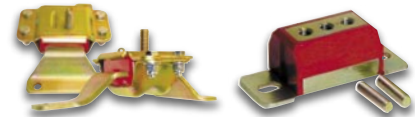

Model	Year	Engine Size	Motor Mount	Trans. Mount	Mtr./Trans. Mount Combo
-------	------	-------------	-------------	--------------	-------------------------

AMC

All Model	64-83	6 cyl.	1-501	N/A	N/A
All Models	67-83	8 cyl.	1-503	N/A	N/A

BUICK

Apollo/Century	73-75	250 6 cyl.	7-506	7-1604	7-1906
Century	81-82	267 8 cyl.	7-506	N/A	N/A
Century	78-80	305 8 cyl.	7-506	7-1604†	7-1906†
Century	77-79	350 8 cyl.	7-506	7-1604	7-1906
Century	81-82	267 8 cyl.	7-506	N/A	N/A
Regal	73-75	250 6 cyl.	7-506	7-1604	7-1906
Regal (Diesel)	82-84	260 6 cyl.	7-506	7-1604	7-1906
Regal (Diesel)	82-84	260 6 cyl.	7-506	7-1604	7-1906
Regal	81-82	267 8 cyl.	7-506	N/A	N/A
Regal	77-78	305 8 cyl.	7-506	7-1604	7-1906
Regal	77-79	350 8 cyl.	7-506	7-1604*	7-1906*
Riveria	77-78	350 8 cyl.	7-506	N/A	N/A
Roadmaster	91-93	305/350	7-506	7-1604	7-1906
Skylark	73-75	250 6 cyl.	7-506	7-1604	7-1906
Skylark	77-79	305 8 cyl.	7-506	7-1604**	7-1906**
Skylark	77-79	350 8 cyl.	7-506	7-1604	7-1906
Le Sabre	78-82	267/305	7-506	7-1604	7-1906
Le Sabre	77-78	350 8 cyl.	7-506	N/A	N/A

*w/ Auto Only / **77-78 Only / †78-79 Only

CHEVROLET

Belair	73	250 6 cyl.	7-506	7-1604	7-1906
Belair	60-72	283/350	7-504	7-1604	7-1901
Belair	73-75	350 8 cyl.	7-506	7-1604	7-1906
Belair	65-67	396 8 cyl.	7-504	7-1604	7-1901
Belair	68-69	396 8 cyl.	7-505	7-1604	7-1902
Belair	70-71	400 8 cyl.	7-505	7-1604	7-1902
Belair	72-76	400 8 cyl.	7-506	7-1604	7-1906
Belair	70-72	402/454	7-505	7-1604	7-1902
Belair	73-76	454 8 cyl.	7-506	7-1604	7-1906
Biscayne	73	250 6 cyl.	7-506	7-1604	7-1906
Biscayne	66-72	250 6 cyl.	7-509	7-1604	7-1907
Biscayne	58-68	283 8 cyl.	7-504	7-1604	7-1901
Biscayne	68	307 8 cyl.	7-504	7-1604	7-1901
Biscayne	62-69	327 8 cyl.	7-504	7-1604	7-1901
Biscayne	70-72	350 8 cyl.	7-505	7-1604	7-1902
Biscayne	73-75	350 8 cyl.	7-506	7-1604	7-1906
Biscayne	70-72	454 8 cyl.	7-505	7-1604	7-1902
Biscayne	73-76	454 8 cyl.	7-506	7-1604	7-1906
Camaro	82-84	173 6 cyl.	7-506	7-1604	7-1906
Camaro	80-81	231 6 cyl.	7-506	7-1604	7-1906
Camaro	69-70	250 6 cyl.	7-504	7-1604	7-1901
Camaro	73-79	250 6 cyl.	7-506	7-1604	7-1906
Camaro	80-81	267 8 cyl.	7-506	7-1604	7-1906
Camaro	67-68	302 8 cyl.	7-504	7-1604	7-1901
Camaro	69	302 8 cyl.	7-505	7-1604	7-1902
Camaro	76-92	305 8 cyl.	7-506	7-1604	7-1906
Camaro	73	307 8 cyl.	7-506	7-1604	7-1906
Camaro	68-72	307-350	7-504	7-1604	7-1901
Camaro	67-69	350 8 cyl.	7-504	7-1604	7-1901
Camaro	72-81	350 8 cyl.	7-506	7-1604	7-1906
Camaro	87-92	350 8 cyl.	7-506	7-1604	7-1906

Model	Year	Engine Size	Motor Mount	Trans. Mount	Mtr./Trans. Mount Combo
-------	------	-------------	-------------	--------------	-------------------------

CHEVROLET Continued

Camaro	93-97	350 8 cyl.	7-508	7-1604	7-1909
Camaro	98-02	350 LS1	7-512	7-1604	7-1908
Camaro	67-70	396 8 cyl.	7-505	7-1604	7-1902
Camaro	70-72	400/402	7-505	7-1604	7-1902
Camaro	74-76	400 8 cyl.	7-506	7-1604	7-1906
Camaro	85-89	2.8 Ltr. 6 cyl.	7-506	7-1604	7-1906
Camaro	93-95	3.4 Ltr. 6 cyl.	N/A	7-1604	N/A
Camaro	96-00	3.8 Ltr. 6 cyl.	N/A	7-1604	N/A
Caprice	77-79	250 6 cyl.	7-506	7-1604	7-1906
Caprice	80-82	267 8 cyl.	7-506	7-1604	7-1906
Caprice	66-67	283 8 cyl.	7-504	7-1604	7-1901
Caprice	77-93	305 8 cyl.	7-506	7-1604	7-1906
Caprice	66-69	327 8 cyl.	7-504	7-1604	7-1901
Caprice	69-73	350 8 cyl.	7-505	7-1604	7-1902
Caprice	74-85	350 8 cyl.	7-506	7-1604	7-1906
Caprice	66-67	396 8 cyl.	7-504	7-1604	7-1901
Caprice	68-69	396 8 cyl.	7-505	7-1604	7-1902
Caprice	74-76	400 8 cyl.	7-506	7-1604	7-1906
Caprice	71-72	402 8 cyl.	7-505	7-1604	7-1902
Chevelle	73-77	250 6 cyl.	7-506	7-1604	7-1906
Chevelle	64-67	283 8 cyl.	7-504	7-1604	7-1901
Chevelle	76-77	305 8 cyl.	7-506	7-1604	7-1906
Chevelle	68-73	307 8 cyl.	7-504	7-1604	7-1901
Chevelle	64-69	327 8 cyl.	7-504	7-1604	7-1901
Chevelle	70-72	350 8 cyl.	7-505	7-1604	7-1902
Chevelle	73-75	350 8 cyl.	7-506	7-1604	7-1906
Chevelle	65-67	396 8 cyl.	7-504	7-1604	7-1901
Chevelle	68-72	396/400	7-505	7-1604	7-1902
Chevelle	73-75	400 8 cyl.	7-506	7-1604	7-1906
Chevelle	70-72	402/454	7-505	7-1604	7-1902
Chevelle	73-75	454 8 cyl.	7-506	7-1604	7-1906
Corvette	63-68	327 8 cyl.	7-504	7-1604	7-1901
Corvette	63-82	350 8 cyl.	7-504	7-1604	7-1901
Corvette	65-67	396 8 cyl.	7-504	7-1604	7-1901
Corvette	80	305 8 cyl.	7-504	7-1604	7-1901
El Camino	65-69	396 8 cyl.	7-504	7-1604	7-1901
El Camino	64-68	327 8 cyl.	7-504	7-1604	7-1901
El Camino	73-77	250 6 cyl.	7-506	7-1604	7-1906
El Camino	79-82	267 8 cyl.	7-506	7-1604	7-1906
El Camino	64-67	283 8 cyl.	7-504	7-1604	7-1901
El Camino	79-88	305 8 cyl.	7-506	7-1604	7-1906
El Camino	68-73	307 8 cyl.	7-504	7-1604	7-1901
El Camino	70-72	350 8 cyl.	7-505	7-1604	7-1902
El Camino	73-81	350 8 cyl.	7-506	7-1604	7-1906
El Camino	68-73	396/400.	7-505	7-1604	7-1902
El Camino	70-73	400 8 cyl.	7-505	7-1604	7-1902
El Camino	70-72	454 8 cyl.	7-505	7-1604	7-1902
Impala	73-79	250 6 cyl.	7-506	7-1604	7-1906
Impala	80-82	267 8 cyl.	7-506	7-1604	7-1906
Impala	58-68	283 8 cyl.	7-504	7-1604	7-1901
Impala	77-85	305 8 cyl.	7-506	7-1604	7-1906
Impala	63-69	327 8 cyl.	7-504	7-1604	7-1901
Impala	69-72	350 8 cyl.	7-505	7-1604	7-1902
Impala	73-83	350/400	7-506	7-1604	7-1906
Impala	74-76	400 8 cyl.	7-506	7-1604	7-1906
Malibu	73-79	250 6 cyl.	7-506	7-1604	7-1906
Malibu (Diesel)	82-83	260 6 cyl.	7-506	7-1604	7-1906





Domestic Vehicle Motor & Transmission Mounts *Continued*



Model	Year	Engine Size	Motor Mount	Trans. Mount	Mtr./Trans. Mount Combo
-------	------	-------------	-------------	--------------	-------------------------

CHEVROLET *Continued*

Malibu	79-82	267 8 cyl.	7-506	7-1604	7-1906
Malibu	77-81	305 8 cyl.	7-506	7-1604	7-1906
Malibu	71-73	307 8 cyl.	7-504	7-1604	7-1901
Malibu	69-72	350 8 cyl.	7-505	7-1604	7-1902
Malibu	73-81	350 8 cyl.	7-506	7-1604	7-1906
Malibu	68-70	396 8 cyl.	7-505	7-1604	7-1902
Malibu	70-73	400 8 cyl.	7-505	7-1604	7-1902
Malibu	74-76	400 8 cyl.	7-506	7-1604	7-1906
Malibu	70-72	454 8 cyl.	7-505	7-1604	7-1902
Malibu	73-75	454 8 cyl.	7-506	7-1604	7-1906
Monte Carlo	75-79	250 6 cyl.	7-506	7-1604	7-1906
Monte Carlo (Diesel)	82-83	260 6 cyl.	7-506	7-1604	7-1906
Monte Carlo	79-82	267 8 cyl.	7-506	7-1604	7-1906
Monte Carlo	79-88	305 8 cyl.	7-506	7-1604	7-1906
Monte Carlo	70-72	350 8 cyl.	7-505	7-1604	7-1902
Monte Carlo	73-81	350 8 cyl.	7-506	7-1604	7-1906
Monte Carlo	70-73	400 8 cyl.	7-505	7-1604	7-1902
Monte Carlo	74-76	400 8 cyl.	7-506	7-1604	7-1906
Monte Carlo	70-72	454 8 cyl.	7-505	7-1604	7-1902
Nova	62-67	283 8 cyl.	7-504	N/A	N/A
Nova	73-79	250 6 cyl.	7-506	7-1604	7-1906
Nova	77-79	305 8 cyl.	7-506	7-1604	7-1906
Nova	68-73	307 8 cyl.	7-504	7-1604	7-1901
Nova	69-71	350 8 cyl.	7-504	7-1604	7-1901
Nova	72	350 8 cyl.	7-505	7-1604	7-1902
Nova	69-71	350 8 cyl.	7-504	7-1604	7-1901
Nova	72	350 8 cyl.	7-505	7-1604	7-1902
Nova	73-79	350 8 cyl.	7-505	7-1604	7-1906
Nova	75-76	262 8 cyl.	7-505	7-1604	7-1906

CHRYSLER/DODGE/PLYMOUTH

"A" Body	67-72	ALL	See Below	4-1602	See Below
"B" Body	66-70	ALL	N/A	4-1602	N/A
"A" Body	73+Up	ALL	See Below	4-1603	See Below
"B" Body	71-74	ALL	See Below	4-1603	See Below
"C" Body	69+	ALL	See Below	4-1603	See Below
"E" Body	70-74	ALL	See Below	4-1603	See Below
"F" "M" & "J" BODY	73+	ALL	See Below	4-1603	See Below
Chrysler					
Cordoba, 5th Ave.	75-89	318 8 cyl.	4-504	4-1603	4-1903
Imperial, LeBaron	75-89	318 8 cyl.	4-504	4-1603	4-1903
New Yorker, Newport	75-89	318 8 cyl.	4-504	4-1603	4-1903
300	75-89	318 8 cyl.	4-504	4-1603	4-1903
Cordoba, LeBaron	74-80	360 8 cyl.	4-504	4-1603	4-1903
New Yorker, Newport	74-80	360 8 cyl.	4-504	4-1603	4-1903
Cordoba, New Yorker	72-78	400 8 cyl.	4-504	4-1603	4-1903
Newport	72-78	400 8 cyl.	4-504	4-1603	4-1903
Imperial, Newport	74-78	440 8 cyl.	4-504	4-1603	4-1903
Dodge					
Aspen, Diplomat	73-89	318 8 cyl.	4-504	4-1603	4-1903
Magnum, Mirada	73-89	318 8 cyl.	4-504	4-1603	4-1903
Monaco, Royal	73-89	318 8 cyl.	4-504	4-1603	4-1903
St. Regis	73-89	318 8 cyl.	4-504	4-1603	4-1903
Challenger, Coronet	73-89	318 8 cyl.	4-504	4-1603*	4-1903

Model	Year	Engine Size	Motor Mount	Trans. Mount	Mtr./Trans. Mount Combo
-------	------	-------------	-------------	--------------	-------------------------

CHRYSLER/DODGE/PLYMOUTH *Continued*

Dodge <i>Continued</i>					
Dart	73-76	318 8 cyl.	4-504	4-1603	4-1903
Dart	71-72	340 8 cyl.	N/A	4-1602	N/A
Dart	73	340 8 cyl.	N/A	4-1603	N/A
Aspen Diplomat	73-80	360 8 cyl.	4-504	4-1603	4-1903
Magnum, Mirada	73-80	360 8 cyl.	4-504	4-1603	4-1903
Monaco, Royal	73-80	360 8 cyl.	4-504	4-1603	4-1903
St. Regis	73-80	360 8 cyl.	4-504	4-1603	4-1903
Challenger, Coronet	73-80	360 8 cyl.	4-504	4-1603*	4-1903*
Charger	73-80	360 8 cyl.	4-504	4-1603*	4-1903*
Dart	73-76	360 8 cyl.	4-504	4-1603	4-1903
Magnum, Royal	74-78	400 8 cyl.	4-504	4-1603	4-1903
Charger, Coronet	74-78	400 8 cyl.	4-504	4-1603**	4-1903**
Magnum, Royal	74-78	400 8 cyl.	4-504	4-1603	4-1903
Charger, Coronet	74-78	400 8 cyl.	4-504	4-1603**	4-1903**
Plymouth					
Fury, Grand Fury	73-89	318 8 cyl.	4-504	4-1603	4-1903
Volare	73-89	318 8 cyl.	4-504	4-1603	4-1903
Scamp, Valiant	73-76	318 8 cyl.	4-504	4-1603	4-1903
Fury, Grand Fury	74-80	360 8 cyl.	4-504	4-1603	4-1903
Volare	74-80	360 8 cyl.	4-504	4-1603	4-1903
Scamp, Valiant	74-76	360 8 cyl.	4-504	4-1603	4-1903
Fury, Grand Fury	73-78	400 8 cyl.	4-504	4-1603	4-1903
Fury	68-73	440 8 cyl.	4-504	4-1603	4-1903
			*73 & 74 Only	**74 Only	

DODGE TRUCKS

Trucks 2WD					
1/2, 3/4 & 1Ton	69-87	3.7L6/5.2 V8	N/A	4-1603	N/A
1/2, 3/4 & 1Ton	72-87	5.9 V8	N/A	4-1603	N/A
1/2, 3/4 & 1Ton	71-78	6.6 V8	N/A	4-1603	N/A
1/2, 3/4 & 1Ton	73-78	7.2 V8	N/A	4-1603	N/A
Trucks 4WD					
1/2 Ton	69-87	3.7 L6	N/A	4-1604	N/A
1/2 Ton	89-93	3.9 L6	N/A	4-1604	N/A
1/2 Ton	70-73	5.2 V8	N/A	4-1604	N/A
1/2, 3/4 Ton	74-93	5.2 V8	N/A	4-1604	N/A
1/2, 3/4 Ton	70-93	5.9 V8	N/A	4-1604	N/A
1/2, 3/4 Ton	74-78	6.6/7.2 V8	N/A	4-1603	N/A
3/4 Ton	69-80	3.7 L6	N/A	4-1604	N/A
3/4 Ton	72-73	5.2 V8	N/A	4-1603	N/A
1 Ton	70-78	3.7 L6	N/A	4-1604	N/A
1 Ton	70-80	5.2 V8	N/A	4-1604	N/A
1 Ton	70-93	5.9 V8	N/A	4-1604	N/A
1 Ton	76-78	6.6 V8	N/A	4-1603	N/A
1 Ton	75-78	7.2 V8	N/A	4-1603	N/A

FORD (Additional Transmission Mount Listing On Pages 38-40)

Fairlane	63-67	289 8 cyl.	6-503 ¹	6-1605 [†]	6-1904 ^{†1}
Falcon	66-68	289 8 cyl.	6-503 ¹	6-1605	6-1904 ¹
Torino	68-71	302/351 8 cyl.	6-503 ¹	6-1605	6-1904 ¹
Mustang	65	260/289 8 cyl.	6-503* ¹	6-1605	6-1904* ¹
Mustang	66-68	289 8 cyl.	6-503 ¹	6-1605	6-1904 ¹
Mustang	68-73	302 8 cyl.	6-503 ¹	6-1605	6-1904 ¹
<small>(Note: Any of the above listed engines will also fit any of the listed years.) 1 Will not fit factory type Hi-Po exhaust manifolds *Requires use of 66-70 frame brackets / †65-67 Only</small>					



Domestic Vehicle Motor & Transmission Mounts *Continued*

Model	Year	Engine Size	Motor Mount	Trans. Mount	Mtr./Trans. Mount Combo
-------	------	-------------	-------------	--------------	-------------------------

FORD *Continued* (Additional Transmission Mount Listing On Pages 38-40)

Mustang	69-73	351 8 cyl.	6-503 [†]	6-1605	6-1904 [†]
(Note: Any of the above listed engines will also fit any of the listed years.)					
Mustang (T-56 Trans.)	79-98	V8	See Below	6-1608**	N/A
Mustang	84-95	5.0 Ltr. V8	6-501	6-1604	6-1905
Mustang	96-98	4.6/5.4 V8	6-504	6-1604 ²	N/A
Mustang	99-04	4.6/5.4 V8	6-504	6-1606	N/A
Mustang	05-06	4.0/4.6 6 & 8 Cyl.	6-505	N/A	N/A
Thunderbird	80-85	5.0 Ltr. 8 Cyl.	6-501	6-1604	6-1905

¹ Will not fit factory type Hi-Po exhaust manifolds

**Conversion mount T-56 6-Speed (may require customer fabrication)

² Does not fit 96-98 GT manual transmission

GM TRUCKS

Trucks 2WD					
C-10 thru C-30	63-69	230 6 cyl.	7-509	7-1604	7-1907
C-10	60-62	235 6 cyl.	7-504	N/A	N/A
C-10 thru C-30	63-72	230/250 6 cyl.	7-509	N/A	N/A
C-10 thru C-30	66-72	250 6 cyl.	7-509	7-1604	7-1907
C-10 thru C-30	73-84	250 6 cyl.	7-506	7-1604	7-1906
C-10 thru C-30	60-62	283 8 cyl.	7-504	7-1604	7-1901
C-10 thru C-30	63-72	283/292 8 cyl.	7-509	7-1604	7-1907
C-10 thru C-30	77-86	305 8 cyl.	7-506	7-1604	7-1906
C-10 thru C-30	65-72	307 8 cyl.	7-509	7-1604	7-1907
C-10 thru C-30	73	307 8 cyl.	7-506	7-1604	7-1906
C-10 thru C-30	65-72	327/350 8 cyl.	7-509	7-1604	7-1907
C-10 thru C-30	63-72	350 8 cyl.	7-509	N/A	N/A
C-10 thru C-30	73-87	350/400	7-506	7-1604	7-1906
C-10 thru C-30	85-86	454 8 cyl.	7-507	7-1604	7-1905
C-10 thru C-30	88-98	454 8 cyl.	7-507	7-1604	7-1905
C-30 thru C-35	73-86	292 6 cyl.	7-506	7-1604	7-1906
C1500 thru C-25	88-98	305 8 cyl.	7-507	7-1604*	7-1905*
C1500 thru C-35	88-98	350 8 cyl.	7-507	7-1604	7-1905

*w/Auto. Only

Trucks 4WD					
K-10 thru K-30	63-69	230 6 cyl.	7-509	N/A	N/A
K-10 thru K-30	66-72	250 6 cyl.	7-5091/2ton	N/A	N/A
K-10 thru K-30	73-84	250 6 cyl.	7-5061/2ton	N/A	N/A
K-10 thru K-30	63-67	283 8 cyl.	7-506	N/A	N/A
K-10 thru K-30	63-72	292 6 cyl.	7-509	N/A	N/A
K-10 thru K-30	65-72	307 8 cyl.	7-509	7-1601 ^{††}	7-1910 ^{††}
K-10 thru K-30	73	307 8 cyl.	7-506	7-1601	7-1903
K-10 thru K-30	69-72	350 8 cyl.	7-509	7-1601 ^{††}	7-1910 ^{††}
K-10 thru K-30	75-84	400 8 cyl.	7-506	7-1601	7-1903
K-10 thru K-30	88-98	454 8 cyl.	7-507	N/A	N/A
K-10 thru K-30	73-84	250 6 cyl.	7-506	7-1601 [†]	7-1903 [†]
K-10 thru K-30	73-84	292 6 cyl.	7-506	7-1604*	7-1906*
K-10 thru K-30	77-87	305 8 cyl.	7-506	7-1601**	7-1903**
K-10 thru K-30	79-87	350 8 cyl.	7-506	7-1601 [†]	7-1903 [†]
K-10 thru K-30	68-72	396 8 cyl.	7-509	7-1604	7-1907
K-20 thru K-30	79-87	454 8 cyl.	7-507	7-1601 [†]	7-1904 [†]
K1500 thru K2500	88-98	305 8 cyl.	7-507	N/A	N/A
K1500 thru K2500	88-98	350 8 cyl.	7-507	N/A	N/A

*w/Auto. Only **77-84 Only †79-84 Only ††68-72 Only

Model	Year	Engine Size	Motor Mount	Trans. Mount	Mtr./Trans. Mount Combo
-------	------	-------------	-------------	--------------	-------------------------

GM TRUCKS *Continued*

Suburban 2WD					
C-10 thru C-30	73-84	250 6 cyl.	7-506	7-1604	7-1906
C-10 thru C-30	77-86	305 8 cyl.	7-506	7-1604	7-1906
R-10 thru R-30	87-90	350 8 cyl.	7-506	7-1604	7-1906
R-10 thru R-30	87-91	454 8 cyl.	7-507	7-1604	7-1905
R-2500 thru K-3500	92-98	350 8 cyl.	7-507	7-1604	7-1905
C-10/20,R-10/20,R1500/2500	63-69	230 6 cyl.	7-509	7-1604	7-1907
C-10/20,R-10/20,R1500/2500	66-72	250 6 cyl.	7-509	7-1604	7-1907
C-10/20,R-10/20,R1500/2500	87-89	292 6 cyl.	7-506	7-1604	7-1906
C-10/20,R-10/20,R1500/2500	85-96	454 8 cyl.	7-507	7-1604	7-1905

Suburban 4WD					
K-10 thru K-30	73-84	250 6 cyl.	7-506	7-1601 [†]	7-1903 [†]
K-10 thru K-30	77-86	305 8 cyl.	7-506	7-1601**	7-1903**
V-10 thru V-30	87-91	454 8 cyl.	7-507	N/A	N/A
K-10/20 & V-10/20	63-69	230 6 cyl.	7-509	N/A	N/A
K-10/20 & V-10/20	66-72	250 6 cyl.	7-509	N/A	N/A
K-10/20 & V-10/20	87-89	292 6 cyl.	7-506	N/A	N/A
K-10/20 & V-10/20	80-91	350 8 cyl.	7-506	N/A	N/A
K-10/20 & V-10/20	92-98	350 8 cyl.	7-507	N/A	N/A
K-10/20 & V-10/20	85-96	454 8 cyl.	7-507	N/A	N/A

*w/Auto. Only **77-84 Only †79-84 Only

Blazer 2WD					
C-10	66-72	250 6 cyl.	7-509	7-1604	7-1907
C-10	73-82	250 6 cyl.	7-506	7-1604	7-1906
C-10	65-72	307 8 cyl.	7-509	7-1604	7-1907
C-10	73	307 8 cyl.	7-506	7-1604	7-1906
C-10	68-72	350 8 cyl.	7-509	7-1604	7-1907
C-10	73-87	350 8 cyl.	7-506	7-1604	7-1906
C-10	88-92	350 8 cyl.	7-507	7-1604	7-1905

Blazer 4WD					
K-10 thru K-30	73-84	292 6 cyl.	7-506	7-1604*	7-1906*
K-10 thru K-30	77-87	305 8 cyl.	7-506	7-1601**	7-1903**
K-10	66-72	250 6 cyl.	7-509	N/A	N/A
K-10	73-82	250 6 cyl.	7-506	N/A	N/A
K-10	77-84	305 8 cyl.	7-506	N/A	N/A
K-10	65-72	307 8 cyl.	7-509	N/A	N/A
K-10	73	307 8 cyl.	7-506	N/A	N/A
K-10	68-72	350 8 cyl.	7-509	N/A	N/A
K-10	73-87	350 8 cyl.	7-506	N/A	N/A
K-10	88-94	350 8 cyl.	7-507	N/A	N/A
K-10	75-78	400 8 cyl.	7-506	N/A	N/A

*w/Auto. Only **74-84 Only

Vans					
G-10 thru G-30	77-90	305/250	7-506	7-1604	7-1906
G-10 thru G-30	64-67	153/194	7-509	7-1604**	7-1907**
G-10 thru G-30	60-62	235 6 cyl.	7-504	7-1604 [†]	7-1901 [†]
G-10 thru G-30	66-70	250 6 cyl.	7-509	7-1604	7-1907
G-10 thru G-30	71-84	250 6 cyl.	7-506	7-1604	7-1906
G-10 thru G-30	68-71	307 8 cyl.	7-509	7-1604	7-1907
G-10 thru G-30	72-81	307/400	7-506	7-1604	7-1906
G-10 thru G-30	88-98	454 8 cyl.	7-507	7-1604	7-1905

**1/2 Ton Only †3/4 Ton Only



Domestic Vehicle Motor & Transmission Mounts *Continued*

Model	Year	Engine Size	Motor Mount	Trans. Mount	Mtr./Trans. Mount Combo
-------	------	-------------	-------------	--------------	-------------------------

JEEP®

All Models	67-92	AMC 8 cyl.	1-503	N/A	N/A
CJ5,CJ7, CJ8	72-86	258 6 cyl.	1-501	7-1604	1-1904††
Cherokee, Wagoneer	72-83	360 8 cyl.	1-503	7-1604	1-1905
Cherokee, Wagoneer	74-85	258 6 cyl.	1-501	7-1604†	1-1904†
Cherokee (XJ)	87-02	6 cyl.	1-502	N/A	N/A
Cherokee (MJ)	87-93	6 cyl.	1-502	N/A	N/A
Grand Wagoneer	80-92	6 cyl.	1-501*	7-1604	1-1904*
Grand Wagoneer	84-91	360 8 cyl.	1-503	7-1604	1-1905
J Series Pickup	63-87	232 6 cyl.	N/A	7-1604**	N/A
J Series Pickup	75-87	360 8 cyl.	1-503	7-1604	1-1905
Wrangler (YJ)	87-96	6 Cyl.	1-502	7-1604	1-1906††
Wrangler (TJ)	97-06	6 Cyl.	1-502	1-1601	1-1903

*84-91 Only **4WD Only †74-83 Only
††Complete Drive Train Kit available, see listings on pg. 48

LINCOLN/MERCURY (Additional Trans Mount Listings on Page 52)

Comet	63-64	260 8 cyl.	6-503**†	N/A	N/A
Comet	63-65	289 8 cyl.	6-503**†	N/A	N/A
Comet	66-69	289 8 cyl.	6-503†	6-1605	6-1904†
Comet	68-70	302 8 cyl.	6-503†	6-1605††	6-1904†††
Continental	82-87	5.0Ltr. 8 cyl.	6-501	N/A	N/A
Cougar	67-68	289 8 cyl.	6-503†	6-1605	6-1904†
Cougar	69-72	351 8 cyl.	6-503†	6-1605	6-1904†
Cougar	67-69	390 8 cyl.	6-503†	6-1605	6-1904†
Cougar	68	427 8 cyl.	6-503†	6-1605	6-1904†
Cougar	68-70	428 8 cyl.	6-503†	6-1605	6-1904†
Cougar	80-82	5.0Ltr 8 cyl.	6-501	6-1604	6-1905
Mark VII	84-92	5.0Ltr. 8 cyl.	6-501	N/A	N/A
Montego	69-71	351 8 cyl.	6-503†	N/A	N/A

†Will not fit factory type Hi-Po exhaust manifolds
**Requires use of 66+ Frame Brackets ††68-69 Only

Model	Year	Engine Size	Motor Mount	Trans. Mount	Mtr./Trans. Mount Combo
-------	------	-------------	-------------	--------------	-------------------------

OLDSMOBILE

Cutlass	73-76	250 6 cyl.	7-506	7-1604	7-1906
Cutlass	78-87	260-350	7-506	7-1604	7-1906
Custom Cruiser	81-82	267 8 cyl.	7-506	N/A	N/A
Custom Cruiser	91-92	305 8 cyl.	7-506	7-1604	7-1906
Custom Cruiser	92	350 8 cyl.	7-506	N/A	N/A
Delta 88	77	350 8 cyl.	7-506	7-1604	7-1906
Delta 88	81-82	267 8 cyl.	7-506	N/A	N/A
Omega/Starfire	77-79	305/350	7-506	7-1604	7-1906

PONTIAC

Astre	79	305 8 cyl.	7-506	N/A	N/A
Bonneville	78-80	267/305	7-506	7-1604	7-1906
Catalina	81	267 8 cyl.	7-506	7-1604	7-1906
Catalina	78-81	305 8 cyl.	7-506	7-1604	7-1906
Firebird	73-76	250 6 cyl.	7-506	7-1604	7-1906
Firebird	80-81	265 8 cyl.	7-506	7-1604	7-1906
Firebird	77-92	267-350	7-506	7-1604	7-1906
Firebird	93-97	350 8 cyl.	7-508	7-1604	7-1909
Firebird	98-02	350 LS1	7-512	7-1604	7-1908
Firebird	93-95	3.4 Ltr. 6 cyl.	N/A	7-1604	N/A
Firebird	96-00	3.8 Ltr. 6 cyl.	N/A	7-1604	N/A
Grand Prix	76-87	305/350	7-506	7-1604	7-1906
Grand Prix	74-76	400/455	7-506	7-1604	7-1906
LeMans	73-76	250 6 cyl.	7-506	7-1604	7-1906
LeMans	77-81	305/350	7-506	7-1604	7-1906
Phoenix	78-79	305/350	7-506	N/A	N/A
Ventura	71-77	250-350	7-506	7-1604	7-1906

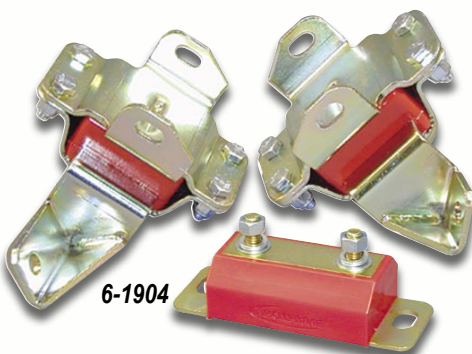

6-1904



4-1903

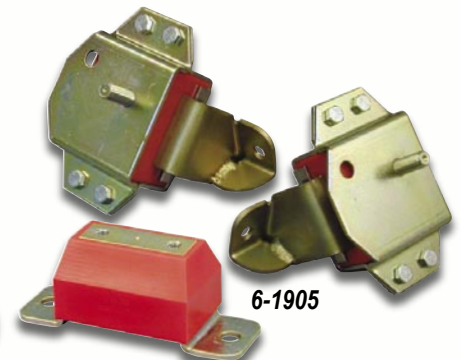

6-1905

Import & Domestic Cars

Make & Model	Year	Kit #	Ball Joint Boots	Body Mounts	C-Arm Front	C-Arm Rear	Drive Train	Shifter Bushings	Shock Bushings	Spring Pds/Coil Iso	Spring/Shackle Rt.	Steering Bushing	Strut Arm/Rod	Strut Tower	Sway Bar Bushing	Sway Bar End Link	Tie Rod Boots	Trans. Mount
Acura Integra • w/o Rr. Upper C-Arm Bushings*	90-93	8-2004	X	X	X		X	X			X	X			X	X		
Acura Integra • w/ All C-Arm Bushings*	90-93	8-2011	X	X	X		X	X			X	X			X	X		
Acura Integra • w/o Rr. Upper C-Arm Bush.	94-01	8-2005	X	X	X		X	X			X	X			X	X		
Acura Integra • w/ All C-Arm Bushings*	94-01	8-2012	X	X	X		X	X			X	X			X	X		
Acura RSX Including Type-S	02-06	8-2019		X	X									X				
AMC Mid Size	64-69	1-2010			X				°	X		X		X	X			
AMC Mid Size	70-83	1-2011			X				°	X		X		X	X			
AMC Full Size	70-83	1-2012			X	X			°			X		X	X			
Buick Century / Skylark	66-72	7-2001	X	X	X										X	X	X	
Buick Century / Skylark	74-77	7-2004	X	X	X										X	X	X	
Buick Regal /Grand National	78-87	7-2007	X	X	X										X	X	X	
Chevrolet Camaro (Multi-Leaf)	67-69	7-2040	X	X	X				X	X					X	X	X	
Chevrolet Camaro (Mono-Leaf)	67-69	7-2002	X	X	X				X	X					X	X	X	
Chevrolet Camaro	70-72	7-2028	X	X	X				X	X					X	X	X	
Chevrolet Camaro	73-74	7-2029	X	X	X				X	X					X	X	X	
Chevrolet Camaro	75-79	7-2005	X	X	X				X	X					X	X	X	
Chevrolet Camaro	80-81	7-2030	X	X	X				X	X					X	X	X	
Chevrolet Camaro	82-92	7-2008	X		X	X	X			X					X	X	X	
Chevrolet Camaro	93-02	7-2009			X	X	X							X	X	X	X	
Chevrolet Caprice / Impala	65-70	7-2015	X	X	X	X						X			X	X	X	
Chevrolet Caprice / Impala	80-90	7-2026	X		X	X			°						X	X	X	
Chevrolet Caprice / Impala	59-64	7-2032			X	X									X	X	X	
Chevrolet Chevelle	68-72	7-2003	X	X	X	X									X	X	X	
Chevrolet Malibu / El Camino / Laguna	74-77	7-2004	X		X	X									X	X	X	
Chevrolet Malibu / El Camino	78-88	7-2007	X		X	X					X				X	X	X	
Chevrolet Corvette	63-82	7-2012	X		X	X	X		X		X				X	X	X	
Chevrolet Corvette	84-96	7-2013			X	X	X		X							X		
Chevrolet Corvette C5	97-04	7-2014			X	X			X							X		
Chevrolet •Includes Motor Mounts*	55-57	7-2010		X	X	X				X					X	X	X	
Chevrolet Monte Carlo	78-88	7-2007	X		X	X									X	X	X	
Chevrolet Nova	62-67	7-2011	X		X				X	X					X	X	X	
Chevrolet Nova (Multi-Leaf)	68-74	7-2040	X	X	X				X	X					X	X	X	
Chevrolet Nova (Mono-Leaf)	68-74	7-2002	X	X	X				X	X					X	X	X	
Chevrolet Nova	75-79	7-2027	X		X					X					X	X	X	
Chrysler PT Cruiser (Including Touring Edition)	01-06	4-2006			X				°						X	X		
Dodge / Plymouth Various	62-76	4-2001			X					X		X			X	X		
Dodge Neon (Including Sport Package)	95-99	4-2002			X	X						X			X	X	X	
Dodge Neon / SRT-4	00-06	4-2007			X							X			X	X		
Ford Focus/SVT	00-06	6-2026			X	X			°					X	X			
Ford Mustang •w/o Trans. Mount*	65-66	6-2004			X					X		X			X	X		
Ford Mustang •w/Trans. Mount*	65-66	6-2024			X					X		X			X	X	X	
Ford Mustang •w/o Trans. Mount*	67-73	6-2001			X					X		X			X	X	X	
Ford Mustang •w/o Trans. Mount*	79-82	6-2029			X	X	X		°		X				X	X		
Ford Mustang V8 •w/Trans. Mount**	79-82	6-2030			X	X	X		°		X				X	X	X	
Ford Mustang •w/o Trans. Mount*	83-84	6-2031			X	X	X		°		X		X		X	X		
Ford Mustang V8 •w/Trans. Mount**	83-84	6-2032			X	X	X		°		X		X		X	X	X	

*6 Cyl. w/Automatic) (°)Coil Isolators



Import & Domestic Cars (continued)

Make & Model	Year	Kit #	Ball Joint Boots	Body Mounts	C-Arm Front	C-Arm Rear	Drive Train	Shifter Bushings	Shock Bushings	Spring Pots/Coil Iso	Spring/Shackle Rr.	Steering Bushings	Strut Arm/Rod	Strut Tower	Sway Bar Bushings	Sway Bar End Links	Tie Rod Boots	Trans. Mount
Ford Mustang •w/o Trans. Mount•	85-93	6-2002		X							X	X						
Ford Mustang, V8 •w/Trans Mount•	85-93	6-2005		X	X	X			X		X	X			X	X	X	
Ford Mustang •w/o Trans. Mount•	94-98	6-2003		X	X	X			X		X	X			X	X		
Ford Mustang, V8 •w/Trans Mount•**	94-98	6-2006		X	X	X			X		X	X			X	X	X	
Ford Mustang (Except Cobra)	99-04	6-2025		X	X				o		X	X			X	X		
Ford Mustang Cobra	99-04	6-2033	X	X	X				o		X	X			X	X		
Ford Mustang GT	05-06	6-2034		X	X		X							X	X			
**Does Not Fit 96-98 GT With Manual Trans																		
Honda Accord •w/o Rr. Upper C-Arm Bush.•	90-93	8-2006	X	X	X			X				X		X	X	X		
Honda Accord •w/ All C-Arm Bushings•	90-93	8-2013	X	X	X			X				X		X	X	X		
Honda Accord •w/o Rr. Upper C-Arm Bush.•	94-97	8-2007	X	X	X			X				X		X	X	X		
Honda Accord •w/ All C-Arm Bushings•	94-97	8-2014	X	X	X			X				X		X	X	X		
Honda Civic	84-87	8-2001	X	X	X		X							X	X	X		
Honda Civic •w/o Rr. Upper C-Arm Bush.•	88-91	8-2002	X	X	X		X	X			X				X	X		
Honda Civic •w/ All C-Arm Bushings•	88-91	8-2009	X	X	X		X	X			X				X	X		
Honda Civic •w/o Rr. Upper C-Arm Bush.•	92-95	8-2003	X	X	X		X	X			X				X	X		
Honda Civic •w/ All C-Arm Bushings•	92-95	8-2010	X	X	X		X	X			X				X	X		
Honda Civic •w/o Upper C-Arms•	96-00	8-2017	X	X	X		X	X						X	X	X		
Honda Civic •w/All C-Arm Bushings•	96-00	8-2008	X	X	X		X	X						X	X	X		
Honda Civic SI •w/ Upper C-Arms•	99-00	8-2015	X	X	X		X	X						X	X	X		
Honda Civic SI •w/o Upper C-Arms•	99-00	8-2016	X	X	X		X	X						X	X	X		
Honda Civic, Including SI	01-05	8-2019		X	X									X				
Honda Prelude	92-96	8-2018	X	X	X		X	o			X						X	
Mazda RX-7	86-91	12-2001	X	X	X									X			X	
Mercury Capri •w/o Trans. Mount•	79-86	6-2002		X	X	X			o		X	X			X			
Mercury Capri •w/Trans. Mount•	79-86	6-2005		X	X	X			o		X	X			X	X	X	
Mitsubishi Eclipse, FWD/AWD	95-99	13-2001		X	X			X						X				
Mitsubishi Eclipse	00-05	13-2002		X	X									X				
Nissan 240SX	89-94	14-2005		oo	X	X					X	X		X	X	X		
Nissan 240SX	95-98	14-2006			X	X					X	X		X	X	X		
Nissan/Datsun 240Z	70-73	14-2001			X	X	X				X	X		X	X	X		
Nissan/Datsun 260/280Z	74-78	14-2002			X	X	X				X	X		X	X	X		
Nissan/Datsun 280ZX	79-83	14-2003			X	X					X	X		X	X	X		
Nissan 300ZX	84-89	14-2004			X	X					X	X		X	X	X		
Oldsmobile Cutlass/442	66-72	7-2001	X	X	X										X	X	X	
Oldsmobile Cutlass/442	74-77	7-2004	X	X	X										X	X	X	
Oldsmobile Cutlass/442	78-87	7-2007	X	X	X										X	X	X	
Pontiac Fiero	84-87	7-2034	X	X	X									X	X	X		
Pontiac Firebird	67-69	7-2002	X	X	X				X	X					X	X	X	
Pontiac Firebird	70-72	7-2028	X	X	X				X	X					X	X	X	
Pontiac Firebird	73	7-2029	X	X	X				X	X					X	X	X	
Pontiac Firebird	74-75	7-2005	X	X	X				X	X					X	X	X	
Pontiac Firebird	76-79	7-2006	X	X	X				X	X					X	X	X	

(o)Coil Isolators (oo) Sub Frame Bushings



Import & Domestic Cars (continued)

Make & Model	Year	Kit #	Ball Joint Boots	Body Mounts	C-Arm Front	C-Arm Rear	Drive Train	Shifter Bushings	Shock Bushings	Spring Pkts/Coil Iso	Spring/Shackle Rt.	Steering Bushings	Strut Arm/Rod	Strut Tower	Sway Bar Bushings	Tie Rod End Links	Trans. Mount
Pontiac Firebird	80-81	7-2031	X	X	X				X	X					X	X	X
Pontiac Firebird	82-92	7-2008			X	X						X		X	X	X	
Pontiac Firebird	93-02	7-2009			X	X	X							X	X	X	X
Pontiac Grand AM	78-81	7-2007	X		X	X									X	X	X
Pontiac Grand Prix	82-88	7-2007	X		X	X									X	X	X
Pontiac GTO	04-06	7-2041			X	X						X		X	X	X	
Pontiac LeMans/GTO	66	7-2037	X		X	X									X	X	X
Pontiac LeMans/GTO	67-72	7-2038	X		X	X									X	X	X
Pontiac LeMans/GTO	74-77	7-2004	X		X	X									X	X	X
Subaru WRX/Impreza	98-05	16-2001			X	X	X							X			
Toyota Celica	00-05	18-2007			X	X								X			
Toyota Corolla GTS/SR5 (RWD)	85-87	18-2010			X	X						X		X	X		
Toyota MR2	85-89	18-2008			X	X					X	X		X			
Toyota MR2	91-95	18-2009			X	X						X		X			
Volkswagen Rabbit/Golf/Jetta	75-84	22-2008			X	X	X	X			X	X					
Volkswagen Golf II/Jetta II	85-98	22-2009			X	X		X			X	X					
Volkswagen Type I	59-65	22-2001			X*		X			X†	X	X				X	X
Volkswagen Type I	66-72	22-2002			X*	X	X			X†	X	X				X	X
Volkswagen Type I	74-77	22-2003			X*	X	X			X†	X	X				X	X
Volkswagen Super Beetle	71-79	22-2004			X	X	X			X†		X		X		X	

(*) Front Beam Bushings (*) Front Beam & Snubber Bushings (†) Spring Plate Grommet (↔) Sub Frame Bushings

14-2006



18-2010



6-2033



Import & Domestic Trucks

Make & Model	Year	Kit #	Axle Pivot	Body Mounts	"C" Bushings	C-Arm Front	C-Arm Rear	Spring Pads	Spring/Shackle Fr.	Spring/Shackle Rr.	Strut Arm/Rod	Sway Bar/Rod	Sway Bar Bushings	Tie Rod End Links	Torque Arms	Track Arm	Track Arm-Fr.	Track Arm-Rr.	Trans. Mount
Chevrolet/GM Full Size 2WD	63-66	7-2023	X				X							X			X	X	
Chevrolet/GM Full Size 2WD	67-72	7-2024	X									X		X			X	X	
Chevrolet/GM Full Size 2WD	73-80	7-2016	X		X				X			X		X				X	
Chevrolet/GM Full Size 2WD	81-87	7-2018	X		X				X			X		X				X	
Chevrolet/GM Full Size 2WD	88-98	7-2021	X		X				X			X	X	X				X	
Chevrolet/GM Full Size 2WD 1500 (All Cabs)	99-06	7-2042	X		X				X			X	X						
Chevrolet/GM Full Size 2WD 2500HD (All Cabs)	01-06	7-2043	X		X				X			X							
Chevrolet/GM Full Size 4WD	73-80	7-2017	X					X	X					X				X	
Chevrolet/GM Full Size 4WD	81-87	7-2019	X					X	X			X		X					
Chevrolet/GM Full Size 4WD (Std. & Xtra Cab)	88-98	7-2022	X		X				X			X		X					
Chevrolet/GM Full Size 4WD 2500HD (All Cabs)	01-06	7-2043	X		X				X			X							
Chevrolet/GM S10 Pickup 2WD STD. Cab	82-04	7-2020	X		X				X			X	X	X					
Chevrolet/GM S10 Pickup 2WD Xtra Cab	82-04	7-2039	X		X				X					X					
Chevrolet/GM S10 Pickup 4WD STD. Cab	83-04	7-2033	X		X				X			X		X	X				
Chevrolet Suburban 1/2 Ton	81-87	7-2025	X		X				X			X		X					X
Chevrolet/GM Blazer 4WD	92-94	7-2035	X		X				X			X	X	X					
Chevrolet/GM Tahoe/Yukon 2WD	96-99	7-2036	X	X	X				X			X	X	X					X
Dodge Full Size 4WD	72-85	4-2016		X				X	X					X					
Dodge Ram Charger 4WD	72-93	4-2017		X				X	X					X					
Dodge Dakota 2WD	87-96	4-2003		X	X				X			X	X						
Dodge Ram 2WD	94-01	4-2004		X	X				X			X	X						
Dodge Ram 4WD	94-01	4-2005		X	X				X			X	X						
Ford Full Size 2WD F100, F150	66-79	6-2020	X	X					X	X				X					
Ford Full Size 2WD F150	87-96	6-2028	X	X					X	X				X					
Ford Full Size 2WD F150 (All Cabs)	97-03	6-2035		X	X				X	X		X	X						
Ford Bronco I	66-77	6-2016		X	X				X	X				X			X		
Ford Full Size 4WD F150	73-79	6-2017		X	X				X	X				X			X		
Ford Full Size 4WD F150	80-96	6-2018	X	X				X	X					X					
Ford Full Size 4WD F150/F250LD (All Cabs)	97-03	6-2036		X	X				X	X		X	X						
Ford Full Size 4WD F250	80-98	6-2027	X	X				X	X					X					
Ford Explorer 4WD	91-94	6-2019	X						X	X		X	X	X					
Ford Bronco II 4WD	84-88	6-2023	X	X					X	X				X					
Ford Ranger 2WD Std. & Xtra Cab	83-97	6-2021	X	X					X	X				X					
Ford Ranger 4WD Std. & Xtra Cab	83-97	6-2022	X	X					X	X				X					
Jeep CJ5/CJ7	55-73	1-2001		X					X	X				X					
Jeep CJ5/CJ7 (w/Trans. Mount)	74-75	1-2013		X					X	X				X					X
Jeep CJ5/CJ7 (w/Trans Mount Order #1-2007)	76-79	1-2002		X					X	X		X	X	X	X				
Jeep CJ5/CJ7 (w/Trans Mount Order #1-2008)	80-86	1-2003		X					X	X		X	X	X	X				
Jeep CJ8 Scrambler (w/Trans. Mount)	81-86	1-2014		X					X	X		X	X	X					X
Jeep Cherokee	84-01	1-2004			X				X					X			X		
Jeep Grand Cherokee	93-98	1-2016			X	X						X	X	X		X	X		
Jeep Wrangler YJ (w/Trans Mount Order #1-2009)	87-96	1-2005		X					X	X				X		X	X		
Jeep Wrangler TJ	97-06	1-2006		X	X	X	X					X		X		X	X		
Toyota 2WD	79-83	18-2001				X			X	X		X	X	X					
Toyota 2WD	84-88	18-2002				X			X	X		X	X	X					
Toyota 2WD	89-94	18-2004				X			X	X		X	X	X					
Toyota 4WD	79-85	18-2016		X				X	X			X	X	X	X				
Toyota 4WD	86-88	18-2003		X	X				X			X	X	X					
Toyota 4WD	89-94	18-2005		X	X				X			X	X	X					
Toyota 4Runner 4WD	84-88	18-2006		X	X			X	X			X	X	X	X				



Acura

BALL JOINT BOOTS

<i>(Integra)</i>		
86-89	Front Ball Joint Boot Kit (2)	19-1712
90-01	Front Ball Joint Boot Kit (4)	8-1701

CONTROL ARM BUSHINGS, FRONT

<i>(Integra, RSX Including Type-S)</i>		
86-89	Control Arm Bushing Kit, Lower	8-201
90-93	Upper Control Arm Bushing Kit	8-217
90-93	Lower Control Arm Bushing Kit	8-210
90-93	Control Arm Bushing Kit, Upper & Lower	8-206
94-01	Upper Control Arm Bushing Kit	8-211
94-01	Lower Control Arm Bushing Kit	8-212
94-01	Control Arm Bushing Kit, Upper & Lower	8-203
02-06	Lower Control Arm Bushing Kit	8-215

CONTROL ARM BUSHINGS, REAR

<i>(Integra, RSX Including Type-S)</i>		
90-01	Upper Control Arm Bushing Kit	8-307
90-01	Lower Control Arm Bushing Kit	8-303
90-01	Compensator Arm Bushing Kit	8-309
90-01	Control Arm Bushing Kit, Upper & Lower	8-310
97-01	Upper Control Arm Bushing Kit (Type-R)	8-307
97-01	Lower Control Arm Bushing Kit (Type-R)	8-317
02-06	Control Arm Bushing Kit, Upper & Lower	8-318

MOTOR MOUNT INSERTS

<i>(Integra)</i>		
90-91	Engine Mount Insert Kit, Left Upper (GSLRS)	8-510
92-93	Engine Mount Insert Kit, Left Upper (GS,LS,RS)	8-516
92-93	Engine Mount Insert Kit, Left Upper (GSR)	8-510
90-93	Trans Mount Insert Kit, Right Upper	8-511
90-93	Firewall Mount Insert Kit, Rear	8-512
90-91	All 3 Mounts Kit (GS,LS,RS)	8-1905
92-93	All 3 Mounts Kit (GS,LS,RS)	8-1908
92-93	All 3 Mounts Kit (GSR)	8-1905
94-01	Engine Mount Insert Kit, Left Upper	8-501
94-01	Trans Mount Insert Kit, Right Upper	8-502
94-01	Firewall Mount Insert Kit, Rear	8-509
94-01	All 3 Mounts Kit	8-1904

REAR TRAILING ARM BUSHINGS

<i>(Integra)</i>		
90-93	Rear Trailing Arm Bushing Kit	8-314
94-01	Rear Trailing Arm Bushing Kit	8-304

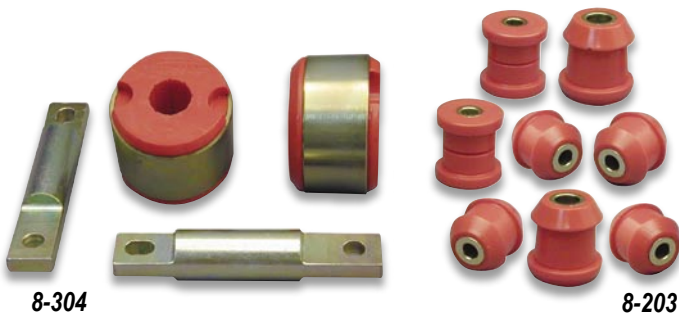

Acura (Continued)

SHIFTER STABILIZER BUSHINGS

<i>(Integra)</i>		
90-01	Shifter Stabilizer Bushing Kit	8-1601

SHOCK BUSHINGS

<i>(Integra)</i>		
90-01	Front Shock Bushing Kit	8-901
90-01	Rear Shock Bushing Kit	8-902

STEERING

<i>(Integra)</i>		
90-93	R & P Bushing Kit, P/S Only	8-703
94-01	R & P Bushing Kit, P/S Only	8-702

STRUT ROD BUSHINGS

<i>(Integra)</i>		
90-93	Front Strut Rod Bushing Kit	8-1203

SWAY BAR & END LINK BUSHINGS, FRONT

<i>(Integra, RSX Including Type-S)</i>		
86-89	Sway Bar Bushing Kit, 16mm Bar*	8-1103
90-93	Sway Bar Bushing Kit, 22mm Bar	8-1118
90-93	Sway Bar Bushing Kit, 23mm Bar	8-1117
94-01	Sway Bar Bushing Kit, 21mm Bar*	8-1101
94-01	Sway Bar Bushing Kit, 21mm Bar	8-1121
94-01	Sway Bar Bushing Kit, 22mm Bar	8-1109
94-01	Sway Bar Bushing Kit, 24mm Bar	8-1110
02-06	Sway Bar Bushing Kit, 23mm Bar	8-1135
90-01	Sway Bar End Link Kit	8-401
	*(Kit Includes End Links)	

SWAY BAR BUSHINGS, REAR

<i>(Integra, RSX Including Type-S)</i>		
90-93	Sway Bar Bushing Kit, 16mm Bar	8-1119
94-01	Sway Bar Bushing Kit, 13mm Bar	8-1111
94-01	Sway Bar Bushing Kit, 14mm Bar	8-1116
02-06	Sway Bar Bushing Kit, 19mm Bar	8-1136

TIE ROD BOOTS

<i>(Integra)</i>		
86-01	Tie Rod Boot Kit (2)	19-1711

TOTAL KITS

<i>(Integra, RSX Including Type-S)</i>		
90-93	Total Kit, w/o Rear Upper C-Arm Bushings*†	8-2004
90-93	Total Kit, w/ Rear Upper C-Arm Bushings*†	8-2011
94-01	Total Kit, w/o Rear Upper C-Arm Bushings*†	8-2005
94-01	Total Kit, w/ Rear Upper C-Arm Bushings*†	8-2012
02-06	Total Kit*	8-2019

(*Total Kits do not contain the Rear Trailing Arm Bushing)
 († Does not include Sway Bar Bushing)



8-304

8-203

8-2012

AMC

BUMP STOPS

(All Models)

70-83	Front Upper C-Arm Bump Stops	19-1312
-------	------------------------------	---------

COIL SPRING ISOLATORS, FRONT

(All Models)

64-69	Front Coil Spring Isolator Kit (4)	1-1706
70-83	Front Upper Spring Isolator Kit (2)	1-1704

CONTROL ARM BUSHINGS, FRONT

(Ambassador, Classic, Marlin, Matador, Rebel)

67-69	Front C-Arm Bushing Kit, w/o Shells	1-206
70-78	Front C-Arm Bushing Kit, w/o Shells	1-207

(American, AMX, Concord, Gremlin, Hornet, Javelin, Rambler, Rogue, Spirit)

64-69	Front C-Arm Bushing Kit, w/o Shells	1-206
64-69	Front Trunion Bushing Only Kit	1-209
64-69	Front Trunion w/Pivot Bushing Kit	1-210
70-83	Front C-Arm Bushing Kit, w/o Shells	1-207

(Eagle, SX-4)

80-88	Front Upper C-Arm Bushing Kit, w/o Shells	1-208
-------	---	-------

CONTROL ARM BUSHINGS, REAR

(Ambassador, Classic, Marlin, Matador, Rebel)

67-78	Rear C-Arm Bushing Kit, w/ Shells	7-225
-------	-----------------------------------	-------

DRIVE TRAIN

(AMX)

68-70	Torque Link Kit	1-1602
-------	-----------------	--------

MOTOR MOUNTS

(All Models)

64-83	Motor Mount Kit., Pair (6 Cyl.)	1-501
67-83	Motor Mount Kit., Pair (8 Cyl.)	1-503

SHOCK BUSHINGS

(All Models)

70-83	Front Shock Bushings (Stem Type, 4 Pcs.)	19-901
-------	--	--------

SPRING & SHACKLE BUSHINGS, REAR

(American, AMX, Concord, Gremlin, Hornet, Javelin, Rambler, Rogue, Spirit)

64-69	Rear HD Shackle Kit Only	1-811
64-69	Spring Eye & Shackle Bushing Kit (w/ 1.5" OD Front Spring Eye)	1-1009
64-69	Spring Eye & HD Shackle Kit	1-1011
70-74	Sprg Eye & Shackle Bushing Kit (AMX, Javelin)	1-1010
70-74	Sprg Eye & HD Shackle Kit (AMX & Javelin)	1-1013
70-74	Rear HD Shackle Kit Only (AMX & Javelin)	1-813
70-83	Sprg Eye & HD Shkl. Kit (Except AMX, Javelin)	1-1012
70-83	Rr HD Shackle Kit Only (Except AMX, Javelin)	1-812
70-83	Spring Eye & Shackle Bushing Kit (w/ 2.0" OD Front Spring Eye)	1-1008

(Spring Kits Listed Above Will Only Fit 2.5" Wide Springs)

(Pacer, Eagle, SX-4)

75-88	Spring Eye & Shackle Bushing Kit (w/ 1.5" OD Front Spring Eye)	1-1009
-------	--	--------

AMC (Continued)

STRUT ROD BUSHINGS

(Ambassador, Classic, Marlin, Matador, Rebel)

62-64	Front Strut Rod Bushing Kit, 5/8"	1-1207
70-78	Front Strut Rod Bushing Kit (2 Piece Design)	6-1205

(American, AMX, Concord, Gremlin, Hornet, Javelin, Rambler, Rogue, Spirit)

64-83	Front Strut Rod Bushing Kit (2 Piece Design)	6-1205
-------	--	--------

(Eagle, SX-4)

80-88	Front Strut Rod Bushing Kit (2 Piece Design)	6-1205
-------	--	--------

SWAY BAR BUSHINGS, FRONT

(Ambassador, Classic, Marlin, Matador, Rebel)

64-78	Front Sway Bar Bushing Kit, 13/16" Bar	1-1120
64-78	Front Sway Bar Bushing Kit, 7/8" Bar	1-1121

(American, AMX, Concord, Gremlin, Hornet, Javelin, Rambler, Rogue, Spirit)

64-83	Front Sway Bar Bushing Kit, 13/16" Bar	1-1120
64-83	Front Sway Bar Bushing Kit, 7/8" Bar	1-1121

(Pacer, Eagle, SX-4)

75-88	Front Sway Bar Bushing Kit, 7/8" Bar	1-1121
-------	--------------------------------------	--------

SWAY BAR BUSHINGS, REAR

(Ambassador, Classic, Marlin, Matador, Rebel)

64-78	Rear Sway Bar Bushing Kit, 3/4" Bar	1-1119
-------	-------------------------------------	--------

(American, AMX, Concord, Gremlin, Hornet, Javelin, Rambler, Rogue, Spirit)

64-83	Rear Sway Bar Bushing Kit, 3/4" Bar	1-1119
-------	-------------------------------------	--------

SWAY BAR END LINKS, FRONT & REAR

(Ambassador, Classic, Marlin, Matador, Rebel)

64-78	End Link Kit	19-408
-------	--------------	--------

(American, AMX, Concord, Gremlin, Hornet, Javelin, Rambler, Rogue, Spirit)

64-83	End Link Kit	19-408
-------	--------------	--------

(Pacer, Eagle, SX-4)

75-88	End Link Kit	19-408
-------	--------------	--------

TRACK BAR

(Ambassador)

63-66	Rear Track Bar Bushing Kit	1-1208
-------	----------------------------	--------

TOTAL KITS

(Ambassador, Classic, Marlin, Matador, Rebel)

70-83	Total Kit	1-2012
-------	-----------	--------

(American, AMX, Concord, Gremlin, Hornet, Javelin, Rambler, Rogue, Spirit)

64-69	Total Kit	1-2010
70-83	Total Kit	1-2011

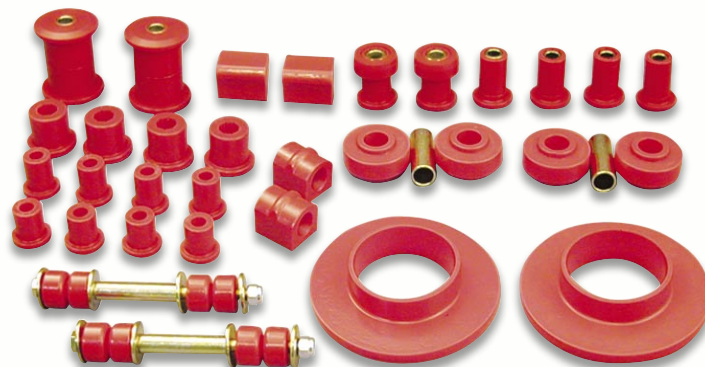

1-2011

Austin

CONTROL ARM BUSHINGS, FRONT

<i>(100/4,100/6,3000)</i>		
54-68	C-Arm Bushing Kit, Lower Inner	24-45109
54-68	C-Arm Bushing Kit, Upper Outer	24-45110
<i>(Sprite Mark 1 & 2)</i>		
60-67	C-Arm Bushing Kit, Lower Inner	26-45045
60-67	C-Arm Bushing Kit, Upper Outer	26-45054
<i>(Sprite Mark 2A & 3)</i>		
60-67	C-Arm Bushing Kit, Lower Inner	26-45045
60-67	C-Arm Bushing Kit, Upper Outer	26-45054

CONTROL ARM BUSHINGS, REAR

<i>(Sprite Mark 1 & 2)</i>		
60-67	C-Arm Bushing Kit	24-46075

SPRING PADS

<i>(100/4,100/6,3000)</i>		
54-68	Rr. Spring Pad Kit	26-47078
<i>(Sprite Mark 2A & 3)</i>		
60-67	Rr. Spring Pad Kit	26-47084

SPRING & SHACKLE BUSHINGS

<i>(Sprite Mark 2A & 3)</i>		
60-67	Rr. Spring, Ft. Eye Bushing Kit	26-47082
60-67	Rr. Spring, Rr. Eye & Shackle Bushing Kit	26-47083

SWAY BAR BUSHINGS

<i>(100/4,100/6,3000)</i>		
54-68	Sway Bar Bushing Kit, 14mm Bar	26-42063

BMW

CONTROL ARM BUSHINGS, FRONT

64-76	C-Arm & Strut Arm Bushing Kit (2002)	3-201
-------	--------------------------------------	-------

CONTROL ARM BUSHINGS, REAR

64-76	C-Arm & Diff. Mount Bushing Kit (2002)	3-202
-------	--	-------

RADIUS RODS, FRONT

74-L	Radius Rod Bushing Kit E28 (525, 528, 535, 635)	3-48098
74-L	Radius Rod Bushing Kit E34 (525, 528, 735,750)	3-48099
84-98	Radius Rod Bushing Kit, E-30 & E36 (3 Series, TI, Z3)	3-48097

STEERING

83-96	Steering Idle Bushing Kit (520i)	3-41067
-------	----------------------------------	---------

SWAY BAR BUSHINGS

64-76	Ft. Sway Bar Bushing Kit, 15mm Bar (2002)	3-42127
64-76	Rr. Sway Bar Bushing Kit, 14mm Bar (2002)	3-42126

SWAY BAR END LINKS

64-76	Ft. End Link Bushing Kit (2002)	3-401
64-76	Rr. End Link Bushing Kit (2002)	3-401

SUB FRAME MOUNTS

64-76	Rr. Sub Frame Mount Insert Kit (2002)	3-101
66-82	Rr. Sub Frame Mount Insert Kit (Bavaria, LS)	3-102
TO-82	Rr. Sub Frame Mount Insert Kit (3, 5, 6 Series)	3-102

TIE ROD BOOTS

64-76	Tie Rod Boot Kit (2) (2002)	19-1711
-------	-----------------------------	---------

Buick

BALL JOINT BOOTS

<i>(Electra, Le Sabre, Centurion, Wildcat)</i>		
85-96	Ball Joint Boot Kit (4)	19-1717
<i>(Century, Regal, Grand National, Skylark thru '72, Special) RWD</i>		
64-72	Ball Joint Boot Kit (4)	19-1715
73-87	Ball Joint Boot Kit (4)	19-1717
<i>(Riviera)</i>		
79-85	Ball Joint Boot Kit (4)	19-1717
<i>(Apollo, Skylark)</i>		
75-79	Ball Joint Boot Kit (4)	19-1717

BODY MOUNTS

<i>(Century, Regal, Grand National, Special) RWD</i>		
82-87	Body Mount Kit	7-132

CONTROL ARM BUSHINGS, FRONT & REAR

<i>(Electra (RWD), Le Sabre (RWD), Centurion, Wildcat)</i>		
71-73	Front C-Arm Bushing Kit, w/Shells	7-212
74-79	Front C-Arm Bushing Kit, w/Shells	7-214
80-94	Front C-Arm Bushing Kit, w/Shells	7-216
65-70	Rear C-Arm Bushing Kit, w/Shells	7-225
<i>(Grand National, Skylark (Thru-72) Special, Regal (RWD), Century (RWD), except Somerset)</i>		
66-72	Front C-Arm Bushing Kit, w/Shells (w/oval lower)	7-222
66-72	Front C-Arm Bushing Kit, w/Shells (w/round. lower)	7-217
73	Front C-Arm Bushing Kit, w/Shells	7-212
74-77	Front C-Arm Bushing Kit, w/Shells	7-214
78-87	Front C-Arm Bushing Kit, w/Shells	7-223
66-87	Rear C-Arm Bushing Kit, w/Shells	7-225
<i>(Riviera)</i>		
71-73	Front C-Arm Bushing Kit, w/Shells	7-212
74-78	Front C-Arm Bushing Kit, w/Shells	7-214
65-70	Rear C-Arm Bushing Kit, w/Shells	7-225
<i>(Somerset)</i>		
87-92	Front C-Arm Bushing Kit, w/o Shells	7-224
<i>(Apollo, Skylark-73&L)</i>		
73-74	Front C-Arm Bushing Kit, w/Shells	7-217
75-79	Front C-Arm Bushing Kit, w/Shells	7-214
87-96	Front C-Arm Bushing Kit, w/o Shells	7-224

COIL SPRING ISOLATORS, REAR

<i>(Century, Regal, Grand National, Skylark thru 72, Special) RWD</i>		
67-87	Coil Spring Isolators, Rear Uppers	7-1706
<i>(Electra, LeSabre, Centurion, Wildcat)</i>		
65-84	Coil Spring Isolators, Rear Uppers	7-1706
<i>(Riviera)</i>		
66-78	Coil Spring Isolators, Rear Uppers	7-1706

MOTOR MOUNTS

Various (See Application Chart on Page 12)

SWAY BAR BUSHINGS

<i>(Somerset)</i>		
85-87	Rear Sway Bar Bushing Kit, 15mm Bar	7-1156
85-87	Rear Sway Bar Bushing Kit, 17mm Bar	7-1157
85-87	Rear Sway Bar Bushing Kit, 19mm Bar	7-1158



Buick (Continued)

SWAY BAR END LINKS, FRONT

(Electra (RWD), Le Sabre (RWD), Centurion, Wildcat)

65-94 End Link Kit 19-408

(Riviera)

65 End Link Kit 19-409

66-78 End Link Kit 19-408

(Grand National, Skylark, Special, Regal (RWD), Century (RWD), except Somerset)

66-72 End Link Kit 19-408

73-77 End Link Kit 19-409

(Apollo, Skylark)

73-94 End Link Kit 19-408

TIE ROD BOOTS

All Tie Rod Boot Kit (2) 19-1712

TRACK ARM BUSHINGS, REAR

(Riviera)

65-70 Rear Track Arm Bushing Kit (Panhard Bar) 7-1210

TRANSMISSION MOUNTS

Various (See Application Chart on Pages 12)

TOTAL KITS

66-72 Total Kit (Century, Skylark) 7-2001

74-77 Total Kit (Century, Regal) 7-2004

78-87 Total Kit (Regal, Grand National) 7-2007

Cadillac

BALL JOINT BOOTS

(All Except El Dorado & '80-'87 Seville)

77-94 Ball Joint Boot Kit (4) 19-1717

CONTROL ARM BUSHINGS

(All Except El Dorado & '80-'87 Seville)

79-83 Front C-Arm Bushing Kit, w/Shells 7-216

77-79 Front C-Arm Bushing Kit, w/Shells 7-214

(Cimarron)

87-88 Front C-Arm Bushing Kit, w/o Shells 7-224

SWAY BAR BUSHINGS, FRONT & REAR

(All Except El Dorado & '80-'87 Seville)

77-96 See Universal Product Guide (Page. 8)

(Cimarron)

87-88 Front Sway Bar Bushing Kit, 24mm Bar 7-1159

87-88 Front Sway Bar Bushing Kit, 26mm Bar 7-1160

87-88 Front Sway Bar Bushing Kit, 28mm Bar 7-1161

87-88 Front Sway Bar Bushing Kit, 30mm Bar 7-1162

87-88 Rear Sway Bar Bushing Kit, 15mm Bar 7-1156

87-88 Rear Sway Bar Bushing Kit, 17mm Bar 7-1157

87-88 Rear Sway Bar Bushing Kit, 19mm Bar 7-1158

SWAY BAR END LINKS

(All)

77-96 Front Sway Bar End Link Kit 19-408

TIE ROD BOOTS

(All)

77-96 Tie Rod Boot Kit (2) 19-1712



Chevrolet Beretta, Cavalier, Cobalt, Corsica, Z-24

CONTROL ARM BUSHINGS, FRONT

<i>(Beretta, Corsica)</i>		
87-96	C-Arm Bushing Kit, w/o Shells	7-224
<i>(Cavalier, Z-24)</i>		
82-86	C-Arm Bushing Kit, w/o Shells	7-233
87-94	C-Arm Bushing Kit, w/o Shells	7-224
95-04	C-Arm Bushing Kit, w/o Shells	7-234

MOTOR MOUNTS

<i>(Cavalier) 5 spd. & Auto. (Non Ecotec)</i>		
95-04	Upper Engine Mount Insert	7-513
95-04	Lower Engine Torque Strut	7-511
95-04	Trans. Insert Kit (Ft. Mount, Manual Only)	7-514
95-04	Trans. Insert Kit (Rr. Mount, Manual Only)	7-515
<i>(Cobalt)</i>		
05-06	Motor Mount Insert Kit, Front Or Rear	7-516

SWAY BAR BUSHINGS, FRONT

<i>(Beretta, Corsica)</i>		
87-96	Sway Bar Bushing Kit, 24mm Bar	7-1159
87-96	Sway Bar Bushing Kit, 26mm Bar	7-1160
87-96	Sway Bar Bushing Kit, 28mm Bar	7-1161
87-96	Sway Bar Bushing Kit, 30mm Bar	7-1162
<i>(Cavalier, Z-24)</i>		
82-94	Sway Bar Bushing Kit, 24mm Bar	7-1159
82-94	Sway Bar Bushing Kit, 26mm Bar	7-1160
82-94	Sway Bar Bushing Kit, 28mm Bar	7-1161
82-94	Sway Bar Bushing Kit, 30mm Bar	7-1162
<i>(Cobalt)</i>		
05-06	Front Sway Bar Bushing Kit, 23mm Bar	7-1190

SWAY BAR BUSHINGS, REAR

<i>(Beretta, Corsica)</i>		
87-96	Sway Bar Bushing Kit, 15mm Bar	7-1156
87-96	Sway Bar Bushing Kit, 17mm Bar	7-1157
87-96	Sway Bar Bushing Kit, 19mm Bar	7-1158
<i>(Cavalier, Z-24)</i>		
88-94	Sway Bar Bushing Kit, 15mm Bar	7-1156
88-94	Sway Bar Bushing Kit, 17mm Bar	7-1157
88-94	Sway Bar Bushing Kit, 19mm Bar	7-1158

BALL JOINT BOOTS

67-69	Front Ball Joint Boot Kit (4)	19-1715
70-81	Front Ball Joint Boot Kit (4)	19-1717

BODY MOUNTS

67-69	Body Mount Kit (Convertible Only, w/Hrdwr)	7-120
67-81	Body Mount Kit (Hardtop Only w/o Hrdwr)	7-119
67-81	Body Mount Kit, (Hardtop Only w/ Hrdwr)	7-139
67-81	Body Mount Hardware Kit, (For 7-119)	7-140

CONTROL ARM BUSHINGS, FRONT

67-69	C-Arm Bushing Kit, w/Shells	7-217
70-72	C-Arm Bushing Kit, w/Shells	7-218
73-74	C-Arm Bushing Kit, w/Shells	7-212
	(w/ 1.625" OD Front Lower Bushing)	
73-74	C-Arm Bushing Kit, w/Shells	7-213
	(w/ 1.375" OD Front Lower Bushing)	

Chevrolet Camaro

CONTROL ARM BUSHINGS, FRONT *Continued*

73-74	C-Arm Bushing Kit, w/Shells	7-213
	(w/ 1.375" OD Front Lower Bushing)	
75-79	C-Arm Bushing Kit, w/Shells	7-214
	(w/ 1.625" OD Front Lower Bushing)	
80-81	C-Arm Bushing Kit, w/Shells	7-219
82-92	C-Arm Bushing Kit, w/Shells (Lower Only)	7-220
93-02	C-Arm Bushing Kit, w/o Shells	7-227

CONTROL ARM BUSHINGS, REAR

82-02	C-Arm Bushing Kit, w/Shells	7-226
-------	-----------------------------	-------

DRIVE TRAIN *(See Diagrams Below)*

84-92	Differential To Trans Torque Arm Kit	7-1611
84-02	Differential To Trans Torque Arm Kit (84-92 Varies)	7-1609
82-02	Panhard Rod Kit	7-1201
82-92	Secondary Trans. Crossmember Kit	7-1605

MOTOR MOUNTS

Various (See Application Chart on Page 12)

RADIATOR ISOLATORS

70-81	Radiator Isolators, Small Block (4pcs)	7-1711
70-81	Radiator Isolators, Big Block (4pcs)	7-1712

SPRING & SHACKLE, OEM & HD REAR

67-69	Spring Eye & Shackle Bushing Kit (Mono Leaf)	7-1010
67-69	Spring Eye & Shackle Bushing Kit (Multi Leaf)	7-1011
70-81	Spring Eye & Shackle Bushing Kit (Multi Leaf)	7-1012
67-81	Spring Eye & HD Shackle Kit (Multi Leaf)**+	7-1050
67-81	Rear HD Shackle Kit Only (Multi Leaf)*+	7-1051
67-69	Spring Eye & HD Shackle Kit (Mono Leaf)**	7-1052
67-69	Rear HD Shackle Kit Only (Mono Leaf)*	7-1053

(*Includes rear only eye bushings, shackle bushings, zinc plated heavy duty steel shackles, bolts and locknuts.)

(**Includes both spring eye bushings, shackle bushings, zinc plated heavy duty steel shackles, bolts and locknuts.)

(+Also fits replacement mono leaf 2.5" wide)

SPRING PADS, REAR

68-69	Spring Pad Kit, Upper or Lower (Multi Leaf)(2)	7-1701
70-81	Spring Pad Kit, Lower (Multi Leaf)	7-1702
70-81	Spring Pad Kit, Upper (Multi Leaf)	7-1703
68-69	Spring Pad Kit, Upper & Lower (Multi Leaf)	7-1708
70-81	Spring Pad Kit, Upper & Lower (Multi Leaf)	7-1709

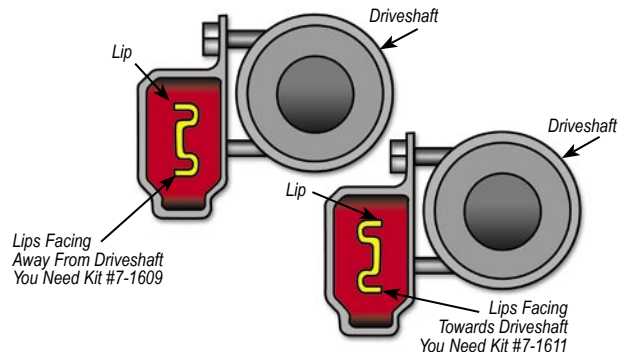

Chevrolet Camaro (Continued)

SPRING PADS, REAR *Continued*

67-69	Spring Pad Kit, Upper (Mono Leaf)	7-1704
67-69	Spring Pad Kit, Lower (Mono Leaf)	7-1705
67-69	Spring Pad Kit, Upper & Lower (Mono Leaf)	7-1707

SWAY BAR BUSHINGS, FRONT

67-81	Front Sway Bar Bushings (See Page 8 For S/B Bushing Listings)	19-XXXX
82-92	Sway Bar Bushing Kit, 30mm Bar	7-1133
82-92	Sway Bar Bushing Kit, 32mm Bar	7-1134
82-92	Sway Bar Bushing Kit, 34mm Bar	7-1135
93-02	Sway Bar Bushing Kit, 30mm Bar	7-1136
93-02	Sway Bar Bushing Kit, 32mm Bar	7-1137

SWAY BAR BUSHINGS, REAR

(2 Bolt Clamp)

67-81	Sway Bar Bushing Kit, 9/16" Bar	7-1116
67-81	Sway Bar Bushing Kit, 5/8" Bar	7-1117
67-81	Sway Bar Bushing Kit, 11/16" Bar	7-1118
67-81	Sway Bar Bushing Kit, 3/4" Bar	7-1119
67-81	Sway Bar Bushing Kit, 13/16" Bar	7-1120
67-81	Sway Bar Bushing Kit, 7/8" Bar	7-1121

(All The Above Kits Include End Link Bushings)

SWAY BAR BUSHINGS, REAR

(1 Bolt Clamp)

67-81	Sway Bar Bushing Kit, 5/8" Bar	7-1122
67-81	Sway Bar Bushing Kit, 11/16" Bar	7-1123
67-81	Sway Bar Bushing Kit, 3/4" Bar	7-1124
67-81	Sway Bar Bushing Kit, 13/16" Bar	7-1125
67-81	Sway Bar Bushing Kit, 7/8" Bar	7-1126
67-81	Sway Bar Bushing Kit, 15/16" Bar	7-1127
67-81	Sway Bar Bushing Kit, 1" Bar	7-1128

(All The Above Kits Include End Link Bushings)

SWAY BAR BUSHINGS, REAR

(Late Model)

82-02	Sway Bar Bushing Kit, 19mm Bar	7-1129
82-02	Sway Bar Bushing Kit, 21mm Bar	7-1130
82-02	Sway Bar Bushing Kit, 23mm Bar	7-1131
82-02	Sway Bar Bushing Kit, 24mm Bar	7-1132

(All The Above Kits Include End Links)

SWAY BAR END LINKS

67-92	Front Sway Bar End Link Kit	19-406
93-02	Front Sway Bar End Link Kit	19-409

TIE ROD BOOTS

67-02	Tie Rod Boot Kit (2)	19-1712
-------	----------------------	---------

TRANSMISSION MOUNTS

67-02	Transmission Mount Kit (6 & 8 Cylinder)	7-1604
82-92	Secondary Trans Crossmember Kit	7-1605

TOTAL KITS

67-69	Total Kit (Mono Leaf)	7-2002
67-69	Total Kit (Multi Leaf)	7-2040
70-72	Total Kit	7-2028
73-74	Total Kit	7-2029

(All The Above Kits Include Transmission Mount)

Chevrolet Camaro (Continued)

TOTAL KITS *Continued*

75-79	Total Kit	7-2005
80-81	Total Kit	7-2030
82-92	Total Kit	7-2008
93-02	Total Kit	7-2009

(All The Above Kits Include Transmission Mount)

Chevrolet Chevelle, El Camino & Monte Carlo

BALL JOINT BOOTS

64-72	Ball Joint Boot Kit (4)	19-1715
73-88	Ball Joint Boot Kit (4)	19-1717

BODY MOUNTS

64	Body Mount Kit (Hardtop & Convertible)	7-137
65-67	Body Mount Kit	7-121
65-67	Body Mount Kit (Convertible Only)	7-122
68-72	Body Mount Kit (Except 70-72 Monte Carlo)	7-123
68-72	Body Mount Kit (Convertible Only)	7-124
68-72	Body Mount Kit (El Camino Only)	7-125
70-72	Body Mount Kit (Monte Carlo Only)	7-126
78-88	Body Mount Kit	7-132

CONTROL ARM BUSHINGS, FRONT

64-65	C-Arm Bushing Kit, w/Shells	7-221
66	C-Arm Bushing Kit, w/Shells (w/ 1.90" OD Lower)	7-221
66	C-Arm Bushing Kit, w/Shells (w/ 1.65" OD Lower)	7-217
67-72	C-Arm Bushing Kit, w/Shells (Oval Lower)	7-222
67-72	C-Arm Bushing Kit, w/Shells (Round Lower)	7-217
73	C-Arm Bushing Kit, w/Shells (w/ 1.625" OD Ft. Lower)	7-212
73	C-Arm Bushing Kit, w/Shells (w/ 1.375" OD Ft. Lower)	7-213
74	C-Arm Bushing Kit, w/Shells (w/ 1.625" OD Ft. Lower)	7-214
74	C-Arm Bushing Kit, w/Shells (w/ 1.375" OD Ft. Lower)	7-215
75-77	C-Arm Bushing Kit, w/Shells	7-214
78-88	C-Arm Bushing Kit, w/Shells	7-223

CONTROL ARM BUSHINGS, REAR

64	C-Arm Bushing Kit, w/o Shells	7-314
65-88	C-Arm Bushing Kit, w/Shells	7-225

COIL SPRING ISOLATORS, REAR

67-88	Coil Spring Isolators, Rear Uppers	7-1706
-------	------------------------------------	--------

MOTOR MOUNTS

Various (See Application Chart on Page 12)

RADIATOR ISOLATORS

(Chevelle & El Camino)

68-72	Radiator Isolators, Small Block (4pcs)	7-1711
68-72	Radiator Isolators, Big Block (4pcs)	7-1712



Chevrolet Chevelle, El Camino & Monte Carlo (Continued)

RADIATOR ISOLATORS *Continued*

(Monte Carlo)

70-77	Radiator Isolators, Small Block (4pcs)	7-1711
70-77	Radiator Isolators, Big Block (4pcs)	7-1712

SWAY BAR BUSHINGS, FRONT

64-88	Front Sway Bar Bushings (See Page 8 For S/B Bushing Listings)	19-XXXX
-------	--	---------

SWAY BAR END LINKS, FRONT

64-72	Sway Bar End Link Kit	19-409
73-77	Sway Bar End Link Kit	19-408
78-88	Sway Bar End Link Kit	19-412

TIE ROD BOOTS

64-88	Tie Rod Boot Kit (2)	19-1712
-------	----------------------	---------

TRANSMISSION MOUNTS

Various (See Application Charts on Page 12)

TOTAL KITS

68-72	Total Kit (Chevelle)	7-2003
74-77	Total Kit (Malibu, El Camino, Laguna)	7-2004
78-88	Total Kit (Malibu, El Camino, Monte Carlo)	7-2007



7-1712



7-225



7-2007

Chevrolet Corvette

BALL JOINT BOOTS

63-96	Ball Joint Boot Kit (4)	19-1715
-------	-------------------------	---------

BODY MOUNT

63-69	Body Mount Kit	7-128
73-82	Body Mount Kit	7-133

CONTROL ARM BUSHINGS, FRONT

63-82	Front C-Arm Bushing Kit, w/Shells	7-210
84-96	Front C-Arm Bushing Kit, w/o Shells	7-228
97-04	Front C-Arm Bushing Kit, w/o Shells	7-232

CONTROL ARM BUSHINGS, REAR

63-82	Rear C-Arm Bushing Kit, w/o Shells	7-303
84-96	Rear C-Arm Bushing Kit, w/o Shells	7-315
97-04	Rear C-Arm Bushing Kit, w/o Shells	7-316

DRIVE TRAIN

80-82	Differential Carrier Bushing Kit	7-1607
63-82	Differential Pinion Mount Grommet Kit	7-1606
84-96	Differential Carrier Bushing Kit	7-1610

MOTOR MOUNTS

Various (See Application Charts on Page 12)

SPRING EYE & SHACKLE BUSHINGS

54-62	Spring Eye & Shackle Bushing Kit, Rear	7-1021
-------	--	--------

SPRING CUSHIONS

63-82	Rear Spring Cushion Kit	7-1019
84-96	Rear Spring Cushion Kit	7-1020
97-04	Rear Spring Cushion Kit	7-1025

STEERING

63-82	Power Steering Ram Bushing Kit	7-701
84-96	R&P Bushing Kit	7-702

STRUT ROD BUSHINGS

63-74	Strut Rod Bushing Kit, Rear	7-1202
75-82	Strut Rod Bushing Kit, Rear	7-1203
84-87	Strut Rod Bushing Kit, Rear*	7-1204
88-96	Strut Rod Bushing Kit, Rear**	7-1205

(*Strut Eye Same Size Each End)

(**Strut Eye Diff. Size Each End, Re-Use All Metal Parts)

SWAY BAR BUSHINGS, FRONT

84-87	Sway Bar Bushing Kit, 22mm Bar*	7-1146
84-87	Sway Bar Bushing Kit, 24mm Bar*	7-1147
84-87	Sway Bar Bushing Kit, 26mm Bar*	7-1148
84-87	Sway Bar Bushing Kit, 30mm Bar*	7-1149
84-87	Sway Bar Bushing Kit, 32mm Bar*	7-1173
88-96	Sway Bar Bushing Kit, 22mm Bar*	7-1150
88-96	Sway Bar Bushing Kit, 24mm Bar*	7-1151
88-96	Sway Bar Bushing Kit, 26mm Bar*	7-1152
88-96	Sway Bar Bushing Kit, 30mm Bar*	7-1153
88-96	Sway Bar Bushing Kit, 32mm Bar*	7-1174
97-04	Sway Bar Bushing Kit, 23mm Bar	7-1163
97-04	Sway Bar Bushing Kit, 26mm Bar	7-1164
97-06	Sway Bar Bushing Kit, 30mm Bar	7-1188
97-04	Sway Bar Bushing Kit, 32mm Bar	7-1177
97-04	Sway Bar Bushing Kit, 38mm Bar	7-1178

*(Includes End Link Bushings)

Chevrolet Corvette (Continued)

SWAY BAR BUSHINGS, REAR

63-82	Sway Bar Bushing Kit, 7/16" Bar*	7-1141
84-96	Sway Bar Bushing Kit, 19mm Bar*	7-1142
84-96	Sway Bar Bushing Kit, 22mm Bar*	7-1143
84-96	Sway Bar Bushing Kit, 24mm Bar*	7-1144
84-96	Sway Bar Bushing Kit, 26mm Bar*	7-1145
97-04	Sway Bar Bushing Kit, 19mm Bar	7-1165
97-04	Sway Bar Bushing Kit, 22mm Bar	7-1166
97-06	Sway Bar Bushing Kit, 23mm Bar	7-1189
97-04	Sway Bar Bushing Kit, 26mm Bar	7-1180
97-06	Sway Bar Bushing Kit, 27mm Bar	7-1179

*(Includes End Link Bushings)

SWAY BAR END LINKS

63-82	Front End Link Kit	19-405
84-87	Front End Link Kit	7-402
88-96	Front End Link Kit	7-403
63-96	Rear End Link Kit	7-401

TIE ROD BOOTS

All	Tie Rod Boot Kit (2)	19-1712
-----	----------------------	---------

TRANSMISSION MOUNTS

63-82	Transmission Mount Kit	7-1604
-------	------------------------	--------

TOTAL KITS

63-82	Total Kit (Includes Trans. Mount)	7-2012
84-96	Total Kit	7-2013
97-04	Total Kit	7-2014

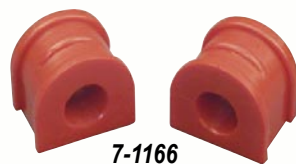

7-1166



7-2012

Chevrolet Bel Air, Biscayne, Caprice & Impala

BALL JOINT BOOTS

64-74	Ball Joint Boot Kit (4)	19-1715
75-96	Ball Joint Boot Kit (4)	19-1717

BODY MOUNTS

55-57	Body Mount Kit (2 & 4 Door Sedans)	7-129
55-57	Body Mount Kit (Convertible Only)	7-130
55-57	Body Mount Kit (2 Door Hardtop Only)	7-131
65-70	Body Mounts Kit (2 Door Hardtop Only)	7-134

COIL SPRING ISOLATORS, REAR

71-90	Coil Spring Isolator Kit, Rear Uppers	7-1706
91-96	Coil Spring Isolator Kit, Rear Uppers	7-1710

CONTROL ARM BUSHINGS, FRONT

55-64	C-Arm Bushing Kit, w/Shells	7-210
65-70	C-Arm Bushing Kit, Upper w/Shells Lower w/o	7-211
71-72	C-Arm Bushing Kit, w/Shells	7-212
73	C-Arm Bushing Kit, w/Shells (w/ 1.625" OD Ft. Lower)	7-212
73	C-Arm Bushing Kit, w/Shells (w/ 1.375" OD Ft. Lower)	7-213
74	C-Arm Bushing Kit, w/Shells (w/ 1.625" OD Ft. Lower)	7-214
74	C-Arm Bushing Kit, w/Shells (w/ 1.375" OD Ft. Lower)	7-215
75-79	C-Arm Bushing Kit, w/Shells	7-214
80-90	C-Arm Bushing Kit, w/Shells	7-216
91-96	C-Arm Bushing Kit, w/Shells	7-230

CONTROL ARM BUSHINGS, REAR

59-64	C-Arm Bush. Kit, w/o Shells (Single Upper Arm)	7-307
59-64	C-Arm Bush. Kit, w/o Shells (Two Upper Arms)	7-308
65-70	C-Arm Bush. Kit, w/o Shells (Single Upper Arm)	7-309
65-70	C-Arm Bush. Kit, w/o Shells (Two Upper Arms)	7-310
69-70	C-Arm Bushing Kit, w/o Shells (V8's Only)	7-313
71-77	C-Arm Bush. Kit, w/o Shells (Exc Stn. Wagon)	7-311
78-96	C-Arm Bushing Kit, w/o Shells	7-312

MOTOR MOUNTS

55-57	Motor Mount Kit, Stock V8	7-503
Various (See Application Chart on Page 12)		

RADIATOR ISOLATORS

70-80	Radiator Isolators, Small Block (4pcs)	7-1711
70-81	Radiator Isolators, Big Block (4pcs)	7-1712

SPRING & SHACKLE, REAR

55	Spring Eye & Shackle Bushing Kit	7-1022
56-57	Spring Eye & Shackle Bushing Kit	7-1023

TRACK BAR BUSHINGS, REAR

59-64	Track Bar Kit, Rear, Panhard	7-1209
65-70	Track Bar Kit, Rear, Panhard	7-1207
65-70	Track Bar Kit, Rear, Panhard (Both Ends the Same 1-1/8" I.D.)	7-1208

STRUT ROD BUSHINGS

65-70	Front Strut Rod Bushing Kit	7-1211
-------	-----------------------------	--------

Chevrolet Bel Air, Biscayne, Caprice & Impala (Continued)

SWAY BAR BUSHINGS, FRONT

55-90	Front Sway Bar Bushings (See Page 8 For S/B Bushing Listings)	19-XXXX
-------	--	---------

SWAY BAR END LINKS, FRONT

55-57	End Link Kit	19-408
58-64	End Link Kit	19-412
65-70	End Link Kit	19-405
71-90	End Link Kit	19-408
91-96	End Link Kit	19-406

TIE ROD BOOTS

55-96	Tie Rod Boot Kit (2)	19-1712
-------	----------------------	---------

TRANSMISSION MOUNTS

Various (See Application Chart on Page 12)

TOTAL KITS

55-57	Total Kit (Sedan, Hardtop)	7-2010
59-64	Total Kit	7-2032
65-70	Total Kit (2 Door Hardtop Only)	7-2015
80-90	Total Kit	7-2026

CHEVROLET Nova

BALL JOINT BOOTS

62-74	Ball Joint Boot Kit (4)	19-1715
75-79	Ball Joint Boot Kit (4)	19-1717

BODY MOUNTS

68-74	Body Mount Kit	7-119
68-74	Body Mount Kit with Hardware	7-139
68-74	Body Mount Hardware Kit Only	7-140

CONTROL ARM BUSHINGS, FRONT

62-67	Control Arm Bushing Kit, w/o Shells	7-229
68-74	Control Arm Bushing Kit, w/Shells	7-217
75-79	Control Arm Bushing Kit, w/Shells	7-214

MOTOR MOUNTS

Various (See Application Chart on Page 13)

Chevrolet Nova (Continued)

RADIATOR ISOLATORS

68-79	Radiator Isolators, Small Block (4pcs)	7-1711
68-79	Radiator Isolators, Big Block (4pcs)	7-1712

SPRING & SHACKLE, OEM & HD REAR

62-67	Spring Eye & Shackle Bushing Kit (Mono Leaf)	7-1018
62-67	Spring Eye & HD Shackle Bushing Kit (Mono Leaf)**	7-1056
68-74	Spring Eye & Shackle Bushing Kit (Mono Leaf)	7-1010
68-79	Spring Eye & Shackle Bushing Kit (Multi Leaf)	7-1011
62-74	HD Shackle Kit Only (Mono Leaf)*	7-1053
68-79	HD Shackle Kit Only (Multi Leaf)*	7-1051
68-74	Spring Eye & HD Shackle Kit (Mono Leaf)**	7-1052
68-79	Spring Eye & HD Shackle Kit (Multi Leaf)**	7-1050

(*Includes rear eye bushings, zinc plated heavy duty steel shackles, bolts & locknuts.)

(**Includes both spring eye bushings, shackle bushings, zinc plated

heavy duty steel shackles, bolts & locknuts.)

SPRING PADS, REAR

62-74	Spring Pad Kit, Upper (Mono Leaf)	7-1704
62-74	Spring Pad Kit, Lower (Mono Leaf)	7-1705
68-79	Spring Pad Kit, Upper or Lower (Multi Leaf)	7-1701
62-74	Spring Pad Kit, Upper & Lower (Mono Leaf), 4Pc.	7-1707
68-79	Spring Pad Kit, Upper & Lower (Multi Leaf), 4Pc.	7-1708

STRUT ARM BUSHINGS

62-67	Front Strut Arm Bushing Kit	7-1206
-------	-----------------------------	--------

SWAY BAR BUSHINGS, FRONT

62-79	Front Sway Bar Bushings (See Page 8 For S/B Bushing Listings)	19-XXXX
-------	--	---------

SWAY BAR END LINKS

62-79	Front End Link Kit	19-406
-------	--------------------	--------

TIE ROD BOOTS

62-79	Tie Rod Boot Kit (2)	19-1712
-------	----------------------	---------

TRANSMISSION MOUNTS

Various (See Application Chart on Page 12)

TOTAL KITS

62-67	Total Kit	7-2011
68-74	Total Kit (Multi Leaf)	7-2040
68-74	Total Kit (Mono Leaf)	7-2002
75-79	Total Kit (w/o Body Mounts)	7-2027

(All The Above Kits Include Trans. Mount)



Chevy/GMC Full Size Trucks

BALL JOINT BOOTS, 2WD

(Pickup 2WD All)

88-98 Ball Joint Boot Kit (4) 19-1716

BODY & CAB MOUNTS, 2WD

(Pickup 2WD 1/2 Ton)

63-66 Standard Cab - 8 Bushing Kit 7-118

67-72 Standard Cab - 12 Bushing Kit 7-101

73-80 Standard Cab - 12 Bushing Kit 7-102

81-87 Standard Cab - 12 Bushing Kit 7-108

88-98 Standard Cab - 12 Bushing Kit 7-112

88-98 Extra Cab Only - 16 Bushing Kit 7-113

(Silverado 1500 2WD 1/2 Ton)

99-06 All Cabs - 16 Bushing Kit 7-141

(Suburban 1500 2WD 1/2 Ton)

81-91 24 Bushing Kit 7-114

(Tahoe, Yukon 2WD)

95-99 20 Bushing Kit 7-136

(Pickup 2WD 3/4 & 1 Ton)

70-72 Standard Cab - 12 Bushing Kit 7-103

73-80 Standard Cab - 12 Bushing Kit 7-104

75-79 Crew Cab Only - 16 Bushing Kit 7-135

81-87 Standard Cab - 12 Bushing Kit 7-108

88-98 Standard Cab - 12 Bushing Kit 7-112

81-91 Crew Cab Only - 16 Bushing Kit 7-111

88-98 Extra Cab Only - 16 Bushing Kit 7-113

(Silverado 2500HD 2WD 3/4 Ton)

01-06 All Cabs - 16 Bushing Kit 7-141

BODY & CAB MOUNTS, 4WD

(Pickup 4WD 1/2, 3/4 & 1 Ton)

67-72 Standard Cab - 12 Bushing Kit 7-103

73-80 Standard Cab - 12 Bushing Kit 7-104

75-79 Crew Cab Only - 16 Bushing Kit 7-135

81-87 Standard Cab - 12 Bushing Kit 7-108

81-91 Crew Cab Only - 16 Bushing Kit 7-111

88-98 Standard Cab - 16 Bushing Kit 7-112

88-98 Extra Cab Only - 16 Bushing Kit 7-113

(Silverado 1500 4WD 1/2 Ton)

99-06 All Cabs - 16 Bushing Kit 7-141

(Silverado 2500HD 4WD 3/4 Ton)

01-06 All Cabs - 16 Bushing Kit 7-141

(Suburban 4WD 1/2 Ton)

81-91 24 Bushing Kit 7-114

(Blazer 4WD 1/2 Ton)

67-72 24 Bushing Kit 7-105

73-77 20 Bushing Kit 7-106

78-80 20 Bushing Kit 7-107

81-91 20 Bushing Kit 7-110

92-94 20 Bushing Kit (2 Door Only) 7-136

(Tahoe, Yukon 4WD)

95-99 20 Bushing Kit 7-136

COIL SPRING LIFT SPACERS

(Pickup 2WD 1/2 Ton)

88-98 Front Coil Spring Lift Kit, 1.5" Lift 7-1715

Chevy/GMC Full Size Trucks (Continued)

CONTROL ARM BUSHINGS, FRONT 2WD

(Pickup 2WD 1/2 Ton)

73-87 Control Arm Bushing Kit, w/o Shells 7-201

88-98 Control Arm Bushing Kit, w/o Shells 7-205

(Silverado 1500 2WD 1/2 Ton)

99-06 Control Arm Bushing Kit, w/o Shells 7-236

(Full Size Blazer To 94, Suburban & Tahoe 2WD, 1/2 Ton)

73-91 Control Arm Bushing Kit, w/o Shells 7-201

92-99 Control Arm Bushing Kit, w/o Shells 7-205

(Pickup 2WD 3/4 & 1 Ton)

88-98 Control Arm Bushing Kit, w/o Shells 7-205

(Silverado 2500HD 2WD 3/4 Ton)

01-06 Control Arm Bushing Kit, w/o Shells 7-237

(Van, 2WD 1/2, 3/4 Ton, G-10, G-20)

73-95 Control Arm Bushing Kit, w/o Shells 7-201

(Astro Van)

85-98 Control Arm Bushing Kit, w/ Shells 7-216

(P-10 2WD Chassis)

73-82 Control Arm Bushing Kit, w/o Shells 7-202

(Upper Bushings Only)

CONTROL ARM BUSHINGS, FRONT 4WD

(Pickup 4WD 1/2, 3/4 & 1 Ton)

88-98 Control Arm Bushing Kit, w/o Shells 7-206

(Silverado 2500HD 4WD 3/4 Ton)

01-06 Control Arm Bushing Kit, w/o Shells 7-237

(Full Size Blazer To 94, Suburban & Tahoe 4WD, 1/2 Ton)

92-99 Control Arm Bushing Kit, w/o Shells 7-206

CONTROL ARM & TRACK BAR, REAR 2WD

(Pickup 2WD 1/2 Ton)

60-72 Track Bar Bushing Kit, w/o Shells 7-302

63-72 Control Arm Bushing Kit, w/o Shells 7-301

MOTOR MOUNTS

Various (See Application Chart on Page 14)

RADIATOR ISOLATORS

(Pickup 1/2, 3/4 & 1 Ton 2WD & 4WD)

73-87 Radiator Isolators, Small Block (4pcs) 7-1711

73-87 Radiator Isolators, Big Block (4pcs) 7-1712

88-98 Radiator Isolators, Small Block (4pcs) 7-1713

88-98 Radiator Isolators, Big Block (4pcs) 7-1714

SPRING & SHACKLE BUSHINGS, REAR 2WD

(Pickup 2WD 1/2, 3/4 & 1 Ton)

88-98 Spring Eye & Shackle Bushing Kit 7-1017

(w/1-3/8" OD Frame Shackle Bushings)

88-98 Spring Eye & Shackle Bushing Kit 7-1054

(w/1-1/2" OD Frame Shackle Bushings)

88-98 Frame Shackle Bushing Kit, 1-1/2" OD 7-807

(Silverado 1500 2WD 1/2 Ton)

99-06 Spring Eye & Shackle Bushing Kit 7-1055

(Silverado 2500HD 2WD 3/4 Ton)

01-06 Spring Eye & Shackle Bushing Kit 7-1055



Chevy/GMC Full Size Trucks (Continued)

SPRING & SHACKLE BUSHINGS, REAR 2WD (Continued)

(Pickup 2WD 1/2, 3/4, 1 Ton w/1550 to 2000 lbs. Spring Rating)

67-87	Spring Eye & Shackle Bushing Kit (w/1-1/2" OD Frame Shackle Bushings)	7-1001
81-87	Spring Eye & Shackle Bushing Kit (w/1-3/8" OD Frame Shackle Bushings)	7-1002
73-87	Frame Shackle Bushing Kit, 1-1/2" OD	7-803
81-87	Frame Shackle Bushing Kit, 1-3/8" OD	7-802

(Pickup 2WD 3/4, 1 Ton with 2600 to 3500 lbs. Spring Rating)

73-87	Spring Eye & Shackle Bushing Kit (w/1-1/2" OD Frame Shackle Bushings)	7-1003
73-87	Spring Eye & Shackle Bushing Kit (w/1-3/4" OD Frame Shackle Bushings)	7-1008
81-87	Spring Eye & Shackle Bushing Kit (w/1-3/8" OD Frame Shackle Bushings)	7-1004
73-87	Frame Shackle Bushing Kit, 1-1/2" OD	7-803
73-87	Frame Shackle Bushing Kit, 1-3/4"	7-804
81-87	Frame Shackle Bushing Kit, 1-3/8" OD	7-802

(Full Size Blazer To 94, Suburban & Tahoe 2WD, 1/2 Ton)

67-91	Spring Eye & Shackle Bushing Kit (w/1-1/2" OD Frame Shackle Bushings)	7-1001
67-91	Spring Eye & Shackle Bushing Kit (w/ 1 3/8" OD Frame Shackle Bushings)	7-1002
92-99	Spring Eye & Shackle Bushing Kit (w/1-3/8" OD Frame Shackle Bushings)	7-1017
67-91	Frame Shackle Bushing Kit, 1-3/8" OD	7-802
67-91	Frame Shackle Bushing Kit, 1-1/2" OD	7-803
92-99	Frame Shackle Bushing Kit, 1-3/8" OD	7-805

SPRING & SHACKLE BUSHINGS, FRONT 4WD

(Pickup 4WD 1/2, 3/4, 1 Ton)

67-70	Spring Eye & Shackle Bushing Kit (w/Frame Shackle Bushings)	7-1014
71-87	Spring Eye & Shackle Bushing Kit (w/Frame Shackle Bushings)	7-1007
67-70	Frame Shackle Bushing Kit	7-806
71-87	Frame Shackle Bushing Kit	7-801

(Full Size Blazer & Suburban, 1/2 Ton 4WD)

67-70	Spring Eye & Shackle Bushing Kit (w/Frame Shackle Bushings)	7-1014
71-87	Spring Eye & Shackle Bushing Kit (w/Frame Shackle Bushings)	7-1007
88-91	Spring Eye & Shackle Bushing Kit (w/Frame Shackle Bushings)	7-1013
67-70	Frame Shackle Bushing Kit	7-806
71-91	Frame Shackle Bushing Kit	7-801

(Pickup, Blazer & Suburban 4WD w/After Market Springs)

73-87	With Rancho Springs (Pickup) (Replacement For RS#954)	7-1015
69-87	With Superlift Springs (Pickup) (Replacement For SL#315)*	7-1009
88-91	With Rancho Springs (Blazer & Suburban)	7-1024
71-91	Frame Shackle Bushing Kit	7-801

* (Does Not Include Frame Shackle Bushings)

Chevy/GMC Full Size Trucks (Continued)

SPRING & SHACKLE BUSHINGS, REAR 4WD

(Pickup 4WD 1/2 Ton)

67-87	Spring Eye & Shackle Bushing Kit (w/1-1/2" OD Frame Shackle Bushings)	7-1001
81-87	Spring Eye & Shackle Bushing Kit (w/1-3/8" OD Frame Shackle Bushings)	7-1002
88-98	Spring Eye & Shackle Bushing Kit (w/1-3/8" OD Frame Shackle Bushings)	7-1017
88-98	Spring Eye & Shackle Bushing Kit (w/1-1/2" OD Frame Shackle Bushings)	7-1054
67-87	Frame Shackle Bushing Kit, 1-3/8" OD	7-802
67-87	Frame Shackle Bushing Kit, 1-1/2" OD	7-803
88-98	Frame Shackle Bushing Kit, 1-3/8" OD	7-805
88-98	Frame Shackle Bushing Kit, 1-1/2" OD	7-807

(Pickup 4WD 3/4 Ton)

67-87	Spring Eye & Shackle Bushing Kit (w/Frame Shackle Bushings)	7-1001
88-98	Spring Eye & Shackle Bushing Kit (w/1-3/8" OD Frame Shackle Bushings)	7-1017
88-98	Spring Eye & Shackle Bushing Kit (w/1-1/2" OD Frame Shackle Bushings)	7-1054
67-87	Frame Shackle Bushing Kit, 1-1/2" OD	7-803
88-98	Frame Shackle Bushing Kit, 1-3/8" OD	7-805
88-98	Frame Shackle Bushing Kit, 1-1/2" OD	7-807

(Silverado 2500HD 4WD 3/4 Ton)

01-06	Spring Eye & Shackle Bushing Kit	7-1055
-------	----------------------------------	--------

(Pickup 4WD 1 Ton)

67-87	Spring Eye & Shackle Bushing Kit (w/1-1/2" OD Frame Shackle Bushings)	7-1001
88-98	Spring Eye & Shackle Bushing Kit (w/1-3/8" OD Frame Shackle Bushings)	7-1017
88-98	Spring Eye & Shackle Bushing Kit (w/1-1/2" OD Frame Shackle Bushings)	7-1054
67-87	Frame Shackle Bushing Kit, 1-1/2" OD	7-803
88-98	Frame Shackle Bushing Kit, 1-3/8" OD	7-805
88-98	Frame Shackle Bushing Kit, 1-1/2" OD	7-807

(Full Size Blazer To 94, Suburban & Tahoe 4WD, 1/2 Ton)

67-91	Spring Eye & Shackle Bushing Kit (w/1-1/2" Frame Shackle Bushings)	7-1001
81-91	Spring Eye & Shackle Bushing Kit (w/1-3/8" Frame Shackle Bushings)	7-1002
92-99	Spring Eye & Shackle Bushing Kit (w/1-3/8" OD Frame Shackle Bushings)	7-1017
67-91	Frame Shackle Bushing Kit, 1-3/8" OD	7-802
67-91	Frame Shackle Bushing Kit, 1-1/2" OD	7-803
92-99	Frame Shackle Bushing Kit, 1-3/8" OD	7-805

(Pickup 4WD 3/4 Ton with 1700 to 2800 lbs. Rating)

73-87	Spring Eye & Shackle Bushing Kit (w/1-1/2" OD Frame Shackle Bushings)	7-1001
81-87	Spring Eye & Shackle Bushing Kit (w/1-3/8" OD Frame Shackle Bushings)	7-1002
88-98	Spring Eye & Shackle Bushing Kit (w/1-3/8" OD Frame Shackle Bushings)	7-1017
73-87	Frame Shackle Bushing Kit, 1-3/8" OD	7-802



Chevy/GMC Full Size Trucks (Continued)

SPRING & SHACKLE BUSHINGS, REAR 4WD (Continued)

(Pickup 4WD 3/4 Ton with 1700 to 2800 lbs. Rating) (Continued)

81-87	Frame Shackle Bushing Kit, 1-1/2" OD	7-803
88-98	Frame Shackle Bushing Kit, 1-3/8" OD	7-805

(Pickup 4WD 3/4, 1 Ton with 3000 to 3500 lbs. Rating)

73-87	Spring Eye & Shackle Bushing Kit (w/1-1/2" OD Frame Shackle Bushings)	7-1003
81-87	Spring Eye & Shackle Bushing Kit (w/1-3/8" OD Frame Shackle Bushings)	7-1004
88-98	Spring Eye & Shackle Bushing Kit (w/1-3/8" OD Frame Shackle Bushings)	7-1017
73-87	Frame Shackle Bushing Kit, 1-3/8" OD	7-802
81-87	Frame Shackle Bushing Kit, 1-1/2" OD	7-803
88-98	Frame Shackle Bushing Kit, 1-3/8" OD	7-805

(Pickup 4WD 1 Ton with 3950 lbs. Rating)

67-72	Spring Eye & Shackle Bushing Kit (w/1-1/2" OD Frame Shackle Bushings)	7-1001
73-87	Spring Eye & Shackle Bushing Kit (w/1-3/4" OD Frame Shackle Bushings)	7-1008
81-87	Spring Eye & Shackle Bushing Kit (w/1-1/2" OD Frame Shackle Bushings)	7-1005
81-87	Spring Eye & Shackle Bushing Kit (w/1-3/8" OD Frame Shackle Bushings)	7-1006
88-98	Spring Eye & Shackle Bushing Kit (w/1-3/8" OD Frame Shackle Bushings)	7-1017
73-87	Frame Shackle Bushing Kit, 1-3/4" OD	7-804
81-87	Frame Shackle Bushing Kit, 1-3/8" OD	7-802
81-87	Frame Shackle Bushing Kit, 1-1/2" OD	7-803
88-98	Frame Shackle Bushing Kit, 1-3/8" OD	7-805

SWAY BAR BUSHINGS, Front & Rear 2WD

(Pickup 2WD 1/2 Ton, C-10)

67-87	Front Sway Bar Bushing Kit, 1-1/16" Bar	7-1101
73-87	Front Sway Bar Bushing Kit, 1-1/4" Bar	7-1102
73-87	Front Sway Bar Bushing Kit, 1-1/8" Bar	7-1109
88-98	Front Sway Bar Bushing Kit, 1-1/4" Bar	7-1110
99-06	Front Sway Bar Bushing Kit, 1.42" Bar (Includes Heavy Duty)	7-1168

(Full Size Blazer TO 94, Suburban & Tahoe 2WD, 1/2 Ton)

73-91	Front Sway Bar Bushing Kit, 1-1/16" Bar	7-1101
73-91	Front Sway Bar Bushing Kit, 1-1/8" Bar	7-1109
73-91	Front Sway Bar Bushing Kit, 1-1/4" Bar	7-1102
92-99	Front Sway Bar Bushing Kit, 1-1/4" Bar	7-1110

(Pickup 2WD 3/4 & 1 Ton)

70-72	Front Sway Bar Bushing Kit, 1-1/16" Bar	7-1101
73-87	Front Sway Bar Bushing Kit, 1-1/4" Bar	7-1102
88-98	Front Sway Bar Bushing Kit, 1-1/4" Bar	7-1110
99-06	Front Sway Bar Bushing Kit, 1.42" Bar (Includes Heavy Duty)	7-1168

(Van 2WD 1/2 & 3/4 Ton, G-10, G-20)

73-94	Front Sway Bar Bushing Kit, 1-1/16" Bar	7-1101
-------	---	--------

(Astro Van)

85-98	Front Sway Bar Bushing Kit, 1-1/4" Bar	7-1110
-------	--	--------

Chevy/GMC Full Size Trucks (Continued)

SWAY BAR BUSHINGS, Front & Rear 2WD (Continued)

(Suburban 2WD)

92-99	Rear Sway Bar Bushing Kit, 22mm Bar	7-1140
-------	-------------------------------------	--------

(Suburban, Tahoe)

00-05	Front Sway Bar Bushing Kit, 1.25" Bar	7-1169
00-05	Front Sway Bar Bushing Kit, 1.42" Bar	7-1168
00-05	Rear Sway Bar Bushing Kit, 1.10" Bar	7-1171
00-05	Rear Sway Bar Bushing Kit, 1.18" Bar	7-1172

(Dually 2WD)

81-87	Rear Sway Bar Bushing Kit, 1-1/16" Bar* *Includes Frame Brackets	7-1103
-------	---	--------

(Trailblazer 2WD)

02-03	Front Sway Bar Bushing Kit, 44mm Bar	7-1186
02-03	Front Sway Bar Bushing Kit, 46mm Bar	7-1184
04-05	Front Sway Bar Bushing Kit, 34mm Bar	7-1187
02-05	Rear Sway Bar Bushing Kit, 24mm Bar	7-1185

SWAY BAR BUSHINGS, Front & Rear 4WD

(Pickup 4WD 1/2, 3/4 & 1 Ton)

73-80	Front Sway Bar Bushing Kit, 1-1/16" Bar	7-1105
73-80	Front Sway Bar Bushing Kit, 1-1/4" Bar	7-1106
81-87	Front Sway Bar Bushing Kit, 1-1/4" Bar	7-1107
88-98	Front Sway Bar Bushing Kit, 1-1/4" Bar	7-1111
88-98	Front Sway Bar Bushing Kit, 1-3/16" Bar	7-1114
99-03	Front Sway Bar Bushing Kit, 1.13" Bar	7-1170
99-03	Front Sway Bar Bushing Kit, 1.42" Bar (Includes Heavy Duty)	7-1168

(Full Size Blazer to 94, Suburban & Tahoe 4WD, 1/2 Ton)

73-80	Front Sway Bar Bushing Kit, 1-1/16" Bar	7-1105
73-80	Front Sway Bar Bushing Kit, 1-1/4" Bar	7-1106
81-91	Front Sway Bar Bushing Kit, 1-1/4" Bar	7-1107
92-99	Front Sway Bar Bushing Kit, 1-1/4" Bar	7-1111
92-99	Front Sway Bar Bushing Kit, 1-3/16" Bar	7-1114

(Suburban/Tahoe 1/2, 3/4 Ton)

00-05	Front Sway Bar Bushing Kit, 1.25" Bar	7-1169
00-05	Front Sway Bar Bushing Kit, 1.42" Bar	7-1168
00-05	Rear Sway Bar Bushing Kit, 1.10" Bar	7-1171
00-05	Rear Sway Bar Bushing Kit, 1.18" Bar	7-1172

TIE ROD BOOTS

(Pickup 2 & 4 WD 1/2, 3/4 & 1 Ton)

63-87	Tie Rod Boot Kit (2)	19-1714
-------	----------------------	---------

(Blazer & Suburban 2WD & 4WD 1/2 Ton)

67-91	Tie Rod Boot Kit (2)	19-1714
92-99	Tie Rod Boot Kit (2)	19-1712

(Van 2WD 1/2, 3/4 Ton, G-10, G-20)

73-96	Tie Rod Boot Kit (2)	19-1714
-------	----------------------	---------

(Pickup 2 & 4 WD 1/2, 3/4 & 1 Ton)

88-98	Tie Rod Boot Kit (2)	19-1712
-------	----------------------	---------

(Astro Van 2WD)

85-98	Tie Rod Boot Kit (2)	19-1712
-------	----------------------	---------

TRANSMISSION & DRIVELINE MOUNTS

(Pickup 4WD 1/2, 3/4 & 1 Ton)

68-84	Mount Kit, Transmission	7-1601
-------	-------------------------	--------



Chevy/GMC Full Size Trucks (Continued)

TRANSMISSION & DRIVELINE MOUNTS (Continued)

<i>(1/2, 3/4 & 1 Ton, Full Size Blazer 4WD)</i>		
60-75	Transfer Case Torque Mount Kit	7-1603
<i>(Full Size Trucks & SUV's)</i>		
Various	(See Application Chart on Page 14)	

TOTAL KITS

<i>(Pickup 1/2 Ton 2WD)</i>		
63-66	Total Kit	7-2023
67-72	Total Kit	7-2024
73-80	Total Kit	7-2016
81-87	Total Kit	7-2018
88-98	Total Kit	7-2021
<i>(Silverado 1500 2WD)</i>		
99-06	Total Kit	7-2042
<i>(Pickup 3/4 Ton 2WD)</i>		
88-98	Total Kit	7-2021
<i>(Silverado 2500HD 2/4WD)</i>		
01-06	Total Kit	7-2043
<i>(Pickup 1/2 Ton, 3/4 Ton 4WD w/ Stock or After Market Springs)</i>		
73-80	Total Kit	7-2017
81-87	Total Kit	7-2019
<i>(Pickup 1/2 Ton, 3/4 Ton & 1 Ton Standard & Extra Cab 4WD)</i>		
88-98	Total Kit	7-2022
<i>(Suburban 1/2 Ton 2WD)</i>		
81-87	Total Kit	7-2025
<i>(Blazer 4WD)</i>		
92-94	Total Kit	7-2035
<i>(Tahoe/Yukon 4WD)</i>		
95-99	Total Kit	7-2035
<i>(Tahoe/Yukon 2WD)</i>		
96-99	Total Kit	7-2036

Chevy/GMC Blazer, Jimmy & S-Series Trucks

2WD 82-04 & 4 WD, 83-04

BODY & CAB MOUNTS, 2WD

82-04	Standard Cab Pickup - 12 Bushing Kit	7-115
82-04	Extended Cab Pickup - 16 Bushing Kit	7-116
82-04	S10 Blazer - 20 Bushing Kit	7-117

BODY & CAB MOUNTS, 4WD

83-04	Standard Cab Pickup - 12 Bushing Kit	7-115
83-04	Extended Cab Pickup - 16 Bushing Kit	7-116
83-04	S10 Blazer-20 Bushing Kit	7-117

CONTROL ARM BUSHINGS, FRONT 2WD

82-04	C-Arm Bushing Kit (w/o Shells)	7-203
82-04	C-Arm Bushing Kit (w/ Shells)	7-231

CONTROL ARM BUSHINGS, FRONT 4WD

83-04	C-Arm Bushing Kit	7-204
-------	-------------------	-------

SPRING & SHACKLE BUSHINGS, REAR 2WD

82-04	Spring Eye & Shackle Bushing Kit (w/1-1/2" Spring Eyes)	7-1016
-------	---	--------

Chevy/GMC Blazer, Jimmy & S-Series Trucks (Cont.)

2WD 82-04 & 4 WD, 83-04

SPRING & SHACKLE BUSHINGS, REAR 4WD

83-04	Spring Eye & Shackle Bushing Kit (w/1-1/2" Spring Eyes)	7-1016
-------	---	--------

SWAY BAR BUSHINGS, Front & Rear 2WD

82-04	Front Sway Bar Bushing Kit, 1" Bar	7-1154
82-04	Front Sway Bar Bushing Kit, 1-1/16" Bar	7-1104
82-04	Front Sway Bar Bushing Kit, 1-1/8" Bar	7-1167
82-04	Front Sway Bar Bushing Kit, 33mm Bar	7-1138
82-04	Rear Sway Bar Bushing Kit, 23mm Bar (w/Stud End To Eye Bolt Type End Links)	7-1139
96-04	Rear Sway Bar Bushing Kit, 23mm Bar (w/Eye Bolt To Eye Bolt Type End Links)	7-1175

SWAY BAR BUSHINGS, Front & Rear 4WD

83-04	Front Sway Bar Bushing Kit, 25mm Bar	7-1112
83-04	Front Sway Bar Bushing Kit, 28mm Bar	7-1113
83-04	Front Sway Bar Bushing Kit, 32mm Bar	7-1155
83-04	Rear Sway Bar Bushing Kit, 23mm Bar (w/Stud End To Eye Bolt Type End Links)	7-1139
96-04	Rear Sway Bar Bushing Kit, 23mm Bar (w/Eye Bolt To Eye Bolt Type End Links)	7-1175

TRANSMISSION & DRIVELINE MOUNTS

<i>(2WD)</i>		
82-04	Transmission Mount Kit	7-1604
<i>(4 WD)</i>		
83-87	Differential Carrier Bushing Kit	7-1602

TIE ROD BOOTS

82-04	Tie Rod Boot Kit (2)	19-1712
-------	----------------------	---------

TOTAL KITS

<i>(Pickup 2WD)</i>		
82-04	Total Kit-Standard Cab	7-2020
82-04	Total Kit-Extended Cab	7-2039
<i>(Pickup 4WD)</i>		
83-04	Total Kit-Standard Cab	7-2033



7-2020



7-1604



Chrysler Dodge/Plymouth/Mid-Size Cars

BODY MOUNTS

(Charger, Coronet, Superbee, Roadrunner, Satellite)

73-81 Body Mount Kit, "B" Body 4-101

BUMP STOPS

("A", "B", "E" Body)

62-76 Lower C-Arm Bump Stop Kit, "A" Body 19-1303

65-79 Lower C-Arm Bump Stop Kit, "B" Body 19-1303

70-74 Lower C-Arm Bump Stop Kit, "E" Body 19-1303

CONTROL ARM BUSHINGS, FRONT

(Dart, Demon, Duster, Swinger, Valiant, Scamp, thru 69 Barracuda)

62-76 C-Arm Bush. Kit, "A" Body w/o Shells Upper Only 4-202

62-76 C-Arm Bush. Kit, "A" Body w/o Shells Lower Only 4-205

62-76 C-Arm Bush. Kit, "A" Body w/o Shells Upper & Lower 4-206

62-76 C-Arm Bush. Kit, "A" Body w/Shells Upper & Lower* 4-215

(Charger, Coronet, Superbee, Roadrunner, Satellite)

65-72 C-Arm Bush. Kit, "B" Body w/o Shells Upper Only 4-202

65-72 C-Arm Bush. Kit, "B" Body w/o Shells Lower Only 4-205

65-72 C-Arm Bush. Kit, "B" Body w/o Shells Upper & Lower 4-206

65-72 C-Arm Bush. Kit, "B" Body w/Shells Upper & Lower* 4-215

73-79 C-Arm Bush. Kit, "B" Body w/o Shells Upper & Lower 4-207

(Challenger, Barracuda)

70-74 C-Arm Bush. Kit, "E" Body w/o Shells Upper Only 4-202

70-74 C-Arm Bush. Kit, "E" Body w/o Shells Lower Only 4-205

70-74 C-Arm Bush. Kit, "E" Body w/o Shells Upper & Lower 4-206

70-74 C-Arm Bush. Kit, "E" Body w/Shells Upper & Lower* 4-215

*(Upper w/Shells, Lower w/o Shells)

Chrysler Dodge/Plymouth/Mid-Size Cars (Continued)

MOTOR MOUNTS

Various (See Application Chart on Page 13)

SPRING & SHACKLE BUSHINGS, REAR

(See Chart Below For Listings)

STRUT ARM BUSHINGS

(Dart, Demon, Duster, Swinger, Valiant, Scamp, thru 69 Barracuda)

66-76 Strut Arm Bushing Kit, "A" Body 4-1202

(Charger, Coronet, Superbee, Roadrunner, Satellite)

65-74 Strut Arm Bushing Kit, "B" Body 4-1202

(Challenger, Barracuda)

70-74 Strut Arm Bushing Kit, "E" Body 4-1202

SWAY BAR BUSHINGS

(Dart, Demon, Duster, Swinger, Valiant, Scamp, thru 69 Barracuda)

67-72 Front Sway Bushing Kit, 7/8 Bar "A" Body 4-1104

67-72 Front Sway Bushing Kit, 15/16 Bar "A" Body 4-1105

73-76 Front Sway Bushing Kit, 13/16" Bar "A" Body 4-1107

73-76 Front Sway Bushing Kit, 7/8" Bar "A" Body 4-1108

73-76 Front Sway Bushing Kit, 15/16" Bar "A" Body 4-1109

(Charger, Coronet, Superbee, Roadrunner, Satellite)

65-69 Front Sway Bushing Kit, 7/8 Bar "B" Body 4-1104

65-69 Front Sway Bushing Kit, 15/16 Bar "B" Body 4-1105

73-79 Front Sway Bushing Kit, 13/16 Bar "B" Body* 4-1106

73-79 Front Sway Bushing Kit, 15/16 Bar "B" Body* 4-1116

(Challenger, Barracuda 70 & later)

70-74 Front Sway Bushing Kit, 7/8" Bar "E" Body 4-1108

*(Includes End Links)

CHRYSLER Dodge/Plymouth (Mid-Size Cars) – SPRING & SHACKLE BUSHINGS, REAR

"A" Body (Dart, Demon, Duster, Swinger, Valiant, Scamp, Barracuda thru 69) & 60-62 "B" Body Dart

Year	Main Eye Bushing Dia.	Main Eye Bolt Dia.	Shackle Bushing Dia.	Part #	Part # w/ HD Shackles
60-62 (Dart)	2"	5/8"	1"	4-1001	4-1010
60-76	2"	5/8"	7/8"	4-1016	4-1015
60-76	1 1/2"	5/8"	7/8"	4-1017	4-1013
60-76	1 1/2"	1/2"	7/8"	4-1004	4-1014
60-76	1 3/8"	7/16"	7/8"	4-1003	4-1012
60-76			1", Shackle Kit Only	4-802	4-804
60-76			7/8", Shackle Kit Only	4-801	4-805
60-67	HD Conversion Shackle Kit To Install Super Stock Springs				4-806
60-67	Spring Eye & HD S/S Conversion Shackle Kit*				4-1018
"B" Body (Charger, Coronet, SuperBee, Roadrunner, Satellite & 60-62 Dart)					
60-72	2"	5/8"	1"	4-1001	4-1010
60-72	1 1/2"	5/8"	1"	4-1002	4-1011
60-72			1", Shackle Kit Only	4-802	4-804
60-62	Spring Eye & HD S/S Conversion Shackle Kit*				4-1018
73-79				4-1009	
73-79			Shackle Kit Only	4-803	
"E" Body (Challenger, Barracuda 70 & Later)					
70-74	2"	5/8"	1"	4-1001	4-1010
70-74	1 1/2"	5/8"	1"	4-1002	4-1011
70-74			1" Shackle Kit Only	7-802	4-804

*For Installation of Super Stock Springs in a Non S/S Equipped Vehicle



Chrysler Dodge/Plymouth/Mid-Size Cars (Continued)

SWAY BAR BUSHINGS (Continued)

(Aspen)		
76-79	Front Sway Bushing Kit, 15/16" Bar*	4-1112
76-79	Front Sway Bushing Kit, 1" Bar*	4-1113
76-79	Front Sway Bushing Kit, 1 1/16" Bar*	4-1114
76-79	Front Sway Bushing Kit, 1 1/8" Bar*	4-1115
(Volare)		
76-80	Front Sway Bushing Kit, 15/16" Bar*	4-1112
76-80	Front Sway Bushing Kit, 1" Bar*	4-1113
76-80	Front Sway Bushing Kit, 1 1/16" Bar*	4-1114
76-80	Front Sway Bushing Kit, 1 1/8" Bar*	4-1115
(*Kits Include End Links)		
(Diplomat)		
77-79	Front Sway Bushing Kit, 15/16" Bar	4-1112
77-79	Front Sway Bushing Kit, 1" Bar	4-1113
77-79	Front Sway Bushing Kit, 1 1/16" Bar	4-1114
77-79	Front Sway Bushing Kit, 1 1/8" Bar	4-1115
(Cordoba & Mirada)		
80-83	Front Sway Bushing Kit, 15/16" Bar	4-1112
80-83	Front Sway Bushing Kit, 1" Bar	4-1113
80-83	Front Sway Bushing Kit, 1 1/16" Bar	4-1114
80-83	Front Sway Bushing Kit, 1 1/8" Bar	4-1115
(Le Baron, Le Baron GTS & Limo)		
77-81	Front Sway Bushing Kit, 15/16" Bar	4-1112
77-81	Front Sway Bushing Kit, 1" Bar	4-1113
77-81	Front Sway Bushing Kit, 1 1/16" Bar	4-1114
77-81	Front Sway Bushing Kit, 1 1/8" Bar	4-1115
(Fifth Ave., Brougham, Grand Fury & Newport)		
82-89	Front Sway Bushing Kit, 15/16" Bar	4-1112
82-89	Front Sway Bushing Kit, 1" Bar	4-1113
82-89	Front Sway Bushing Kit, 1 1/16" Bar	4-1114
82-89	Front Sway Bushing Kit, 1 1/8" Bar	4-1115
(Imperial)		
81-83	Front Sway Bushing Kit, 15/16" Bar	4-1112
81-83	Front Sway Bushing Kit, 1" Bar	4-1113
81-83	Front Sway Bushing Kit, 1 1/16" Bar	4-1114
81-83	Front Sway Bushing Kit, 1 1/8" Bar	4-1115
(All The Above Kits Include End Link Bushings)		

SWAY BAR END LINKS

(Dart, Demon, Duster, Swinger, Valiant, Scamp, Barracuda - thru 69)		
65-72	End Link Kit, "A" Body	19-408
73-76	End Link Kit, "A" Body	19-405
(Charger, Coronet, Superbee, Roadrunner, Satellite)		
65-72	End Link Kit, "B" Body	19-408
(Challenger, Barracuda - 70 & Later)		
70-74	End Link Kit, "E" Body	19-405

TIE ROD BOOTS

62-76	Tie Rod Boot Kit, "A" Body All (2)	19-1712
65-79	Tie Rod Boot Kit, "B" Body All (2)	19-1712
70-74	Tie Rod Boot Kit, "E" Body All (2)	19-1712

TORSION BAR CROSS MEMBER

(Charger, Coronet, Superbee, Roadrunner, Satellite)		
73-79	Torsion Bar Cross Member Mount Kit, "B" Body	4-106

Chrysler Dodge/Plymouth/Mid-Size Cars (Continued)

TORSION BAR DUST BOOTS

(Dart, Demon, Duster, Swinger, Valiant, Scamp, Barracuda thru 69)		
62-76	Torsion Bar Dust Boot Kit, "A" Body	4-1701
(Charger, Coronet, Superbee, Roadrunner, Satellite)		
62-79	Torsion Bar Dust Boot Kit, "B" Body	4-1701
(Challenger, Barracuda 70 & Later)		
70-74	Torsion Bar Dust Boot Kit, "E" Body	4-1701

TRANSMISSION MOUNTS

(Chrysler, Dodge & Plymouth)		
67-72	Transmission Mount Kit A-Body	4-1602
73+	Transmission Mount Kit A-Body	4-1603
66-70	Transmission Mount Kit B-Body	4-1602
71*	Transmission Mount Kit B-Body	4-1603
72-74	Transmission Mount Kit B-Body	4-1603
69+	Transmission Mount Kit C-Body	4-1603
70-74	Transmission Mount Kit E-Body	4-1603
73+	Trans. Mount Kit, F, M, J-Body	4-1603

*Changed Mid-Year

(Additional Transmission Mount Listings on page 13)

TOTAL KITS

62-76	"A" Body	4-2001
65-74	"B" Body	4-2001
70-74	"E" Body	4-2001

Chrysler Dodge/Plymouth/Neon, PT Cruiser

BUMP STOPS

(PT Cruiser)		
01-06	Rear Bump Stop Kit	4-1301

COIL SPRING ISOLATORS

(PT Cruiser)		
01-06	Front Coil Spring Isolator Kit, Lower	4-1704
01-06	Rear Coil Spring Isolator Kit, Upper & Lower	4-1705

CONTROL ARM BUSHINGS, FRONT

(Neon, SRT-4)		
95-99	Front C-Arm Bushing Kit	4-209
00-06	Front C-Arm Bushing Kit	4-214
(PT Cruiser)		
01-06	Front C-Arm Bushing Kit	4-214

CONTROL ARM BUSHINGS, REAR

(Neon, SRT-4)		
95-99	Rear C-Arm Bushing Kit	4-301
00-06	Rear Trailing Arm Bushing Kit	4-304
(PT Cruiser)		
01-06	Rear Trailing Arm Bushing Kit	4-302
01-06	Rear Watts Linkage Bushing Kit	4-303

END LINK BUSHINGS, Front & Rear

(Neon)		
95-99	Front End Link Kit	4-401
95-99	Rear End Link Kit (sport package only)	4-402



Chrysler Dodge/Plymouth/Neon, PT Cruiser (Continued)

END LINK BUSHINGS, Front & Rear (Continued)

(Neon, SRT-4)

00-06	Front End Link Kit	4-401
00-06	Rear End Link Kit	19-413

(PT Cruiser)

01-06	Front End Link Kit	4-401
01-06	Rear End Link Kit	4-403

MOTOR MOUNT INSERTS

(Neon-SOHC, DOHC & SRT-4)

95-99	Engine Mount Insert Kit, Front	4-501
95-99	Engine Mount Insert Kit, Right	4-502
95-99	Transmission Mount Insert Kit, Left	4-503
95-99	All 3 Mounts, Kit	4-1901
95-99	All 3 Mounts, Kit (Softer Street Style)	4-1902
00-06	Upper & Lower Mount Insert Kit (Race)	4-1905
00-06	Upper & Lower Mount Insert Kit (Street)	4-1906

SHIFTER BUSHINGS

(Neon)

95-06	Shifter Bushing Kit	4-1605
03-06	SRT-4 Shifter Bushing Kit	4-1606

STRUT ROD BUSHINGS

(Neon, SRT-4)

95-99	Rear Strut Rod Bushing Kit	4-1204
00-06	Rear Strut Rod Bushing Kit	4-1206

SWAY BAR BUSHINGS, Front & Rear

(Neon, SRT-4)

95-06	Front Sway Bar Bushing Kit, 20mm Bar	4-1118
95-99	Front Sway Bar Bushing Kit, 22mm Bar	4-1119
00-06	Front Sway Bar Bushing Kit, 24mm Bar	4-1120
95-99	Rear Sway Bar Bushing Kit, 16mm Bar *(Sport Package only)	4-1111*
00-06	Rear Sway Bar Bushing Kit, 12mm Bar	4-1130
00-06	Rear Sway Bar Bushing Kit, 14mm Bar	4-1131
00-06	Rear Sway Bar Bushing Kit, 17mm Bar	4-1137

(PT Cruiser)

01-06	Front Sway Bar Bushing Kit, 22mm Bar	4-1119
01-06	Front Sway Bar Bushing Kit, 24mm Bar *(Touring Edition)	4-1120*
01-06	Rear Sway Bar Bushing Kit, 18mm	4-1136

TIE ROD BOOTS

(Neon)

95-99	Tie Rod Boot Kit (2)	19-1711
-------	----------------------	---------

TOTAL KITS

(Neon)

95-99	Total Kit (Includes Sport Package)	4-2002
00-06	Total Kit (Neon, SRT-4)	4-2007

(PT Cruiser)

01-06	Total Kit (Includes Touring Edition)	4-2006
-------	--------------------------------------	--------

Dodge Trucks

BODY MOUNTS

(D100-300, W100-300)

72-85	Body Mount Kit	4-102
-------	----------------	-------

(AD100-150, AW100-150 Ramcharger)

72-93	Body Mount Kit	4-103
-------	----------------	-------

(RAM 1500, 2500, 3500 2 & 4WD)

94-01	Body Mount Kit (Standard Cab)	4-107
-------	-------------------------------	-------

94-01	Body Mount Kit (Club Cab)	4-108
-------	---------------------------	-------

(D50 2WD)

79-87	Body Mount Kit	4-104
-------	----------------	-------

(Dakota 2WD)

87-96	Body Mount Kit, Standard Cab	4-105
-------	------------------------------	-------

COIL SPRING LIFT SPACERS

(Ram 1500, 2500, 3500 4WD)

94-05	Front Coil Spring Lift Kit, 2" Lift	4-1702
-------	-------------------------------------	--------

(Ram 1500, 2500, 3500 2WD)

94-01	Front Coil Spring Lift Kit, 2" Lift	4-1703
-------	-------------------------------------	--------

(Ram 1500 2WD)

02-05	Front Coil Spring Lift Kit, 2" Lift	4-1706
-------	-------------------------------------	--------

(Dakota 2WD)

87-03	Front Coil Spring Lift Kit, 2" Lift	4-1703
-------	-------------------------------------	--------

CONTROL ARM BUSHINGS, FRONT

(D100-300, AD 100-150-2WD)

72-93	C-Arm Bushing Kit, w/o Shells	4-203
-------	-------------------------------	-------

Up to 3,600 lb. Axle w/o Heavy Duty Package

72-93	C-Arm Bushing Kit, w/o Shells	4-204
-------	-------------------------------	-------

Up to 3,800 to 4,000 lb. Axle w Heavy Duty Pk.

(RAM 1500, 2500, 3500 2WD)

94-01	C-Arm Bushing Kit, w/o Shells	4-210
-------	-------------------------------	-------

(RAM 1500, 2500, 3500 4WD)

94-01	C-Arm Bushing Kit, w/o Shells	4-211
-------	-------------------------------	-------

(D50 2WD)

79-90	C-Arm Bushing Kit, Lower Only w/o Shells	4-201
-------	--	-------

(Dakota 2WD)

87-96	C-Arm Bushing Kit, Uppers w/o Shells	4-208
-------	--------------------------------------	-------

97-03	C-Arm Bushing Kit	4-212
-------	-------------------	-------

(Upper w/o Shells, Lower w/ Shells)

(Dakota 4WD)

97-03	C-Arm Bushing Kit, w/o Shells	4-213
-------	-------------------------------	-------

SPRING & SHACKLE BUSHINGS, Front & Rear

(D100-300, AD 100-150 & AW100-150-2&4WD W100-300)

72-93	Spring Eye Bushing Kit (Ft. or Rr. 4WD/Rr. 2WD) (w/1.000" ID Spring Eye)	4-1005
-------	---	--------

(Ram 1500-3500 2WD & 4WD)

94-99	Rear Spring Eye & Shackle Bushing Kit (w/2 1/2" O/D Main Eye & 2 1/2" Wide Spring)	4-1008
-------	---	--------

(D50 2WD)

79-90	Rear Spring Eye & Shackle Bushing Kit	4-1006
-------	---------------------------------------	--------

(Dakota 2WD & 4WD)

87-96	Rear Spring Eye & Shackle Bushing Kit	4-1007
-------	---------------------------------------	--------

Dodge Trucks (Continued)

STRUT ARM BUSHINGS

(D100-300, AD 100-150, 2WD)

72-93 Strut Arm Bushing Kit 4-1203

(D50 2WD)

79-93 Strut Arm Bushing Kit 4-1201

SWAY BAR BUSHINGS, Front & Rear

(D50 2WD,4WD)

79-90 Front Sway Bar Bushing Kit, 7/8" Bar 4-1101

(Ram 1500, 2500, 3500 2WD & 4WD)

94-01 Front Sway Bar Bushing Kit, 30mm Bar 4-1102

94-01 Front Sway Bar Bushing Kit, 32mm Bar 4-1103

94-05 Front Sway Bar Bushing Kit, 34mm Bar 4-1138

(Dakota 2WD)

87-96 Front Sway Bar Bushing Kit, 28mm Bar 4-1110

97-01 Front Sway Bar Bushing Kit, 28mm Bar 4-1117

97-01 Front Sway Bar Bushing Kit, 30mm Bar 4-1102

(Dakota 4WD)

97-99 Front Sway Bar Bushing Kit, 28mm Bar 4-1132

97-99 Front Sway Bar Bushing Kit, 33mm Bar 4-1133

00-01 Front Sway Bar Bushing Kit, 33mm Bar 4-1134

00-01 Front Sway Bar Bushing Kit, 35mm Bar 4-1135

(Dakota 2WD & 4WD)

97-98 Rear Sway Bar Bushing Kit, 15mm Bar 4-1125

99-01 Rear Sway Bar Bushing Kit, 22mm Bar 4-1126

(Durango 2WD)

99-01 Front Sway Bar Bushing Kit, 28mm Bar 4-1117

99-01 Front Sway Bar Bushing Kit, 30mm Bar 4-1102

(Durango 2WD & 4WD)

98-01 Rear Sway Bar Bushing Kit, 18mm Bar 4-1127

98-01 Rear Sway Bar Bushing Kit, 22mm Bar 4-1128

98-01 Rear Sway Bar Bushing Kit, 16mm Bar 4-1129

(Durango 4WD)

98-99 Front Sway Bar Bushing Kit, 28mm Bar 4-1132

98-99 Front Sway Bar Bushing Kit, 33mm Bar 4-1133

Dodge Trucks (Continued)

SWAY BAR BUSHINGS, Front & Rear (Continued)

(Durango 4WD)

00-01 Front Sway Bar Bushing Kit, 33mm Bar 4-1134

00-01 Front Sway Bar Bushing Kit, 35mm Bar 4-1135

TIE ROD BOOTS

(D50-2WD)

79-90 Tie Rod Boot Kit (2) 19-1712

(Dakota 2WD)

97-03 Tie Rod Boot Kit (2) 19-1714

(D100-300, Ramcharger (AD 100-150)-2WD)

69-93 Tie Rod Boot Kit (2) 19-1712

(W100-300, Ramcharger (AW 100-150)-4WD)

69-93 Tie Rod Boot Kit (2) 19-1712

(Van B100-300)

70-93 Tie Rod Boot Kit (2) 19-1712

TRACK ARM BUSHINGS

(RAM 1500, 2500, 3500 4WD)

94-01 Front Track Arm Bushing Kit 4-1205

TRANSMISSION MOUNTS

(D100-300, Ramcharger AD 100)

72-87 Trans. Mount Kit, 225,318,360,C.I.E. 2WD 4-1601

(W100-300, Ramcharger AW 100)

72-78 Transmission Mount Kit, 225 C.I.E. 4WD 4-1601

(Van B100-300 2WD)

69-78 Trans Mount Kit, 198,225,318,360,400 C.I.E. 4-1601

79-81 Trans Mount Kit, 318,360,400,440 C.I.E. 4-1601

82-87 Trans Mount Kit, 198,225,318,360,400,440 C.I.E. 4-1601

(Additional Transmission Mount Listings on page 13)

TOTAL KITS

72-85 Total Kit (W100-300-4WD) 4-2016

72-93 Total Kit (Ramcharger-4WD) 4-2017

87-96 Total Kit (Dakota 2WD) 4-2003

94-01 Total Kit (Ram 1500, 2500, 3500 2WD) Std. Cab 4-2004

94-01 Total Kit (Ram 1500, 2500, 3500 4WD) Std. Cab 4-2005



Ford Focus

BUMP STOPS, Front & Rear

00-06	Front Strut Bump Stop Kit	6-1302
00-06	Rear Bump Stop Kit	6-1301

COIL SPRING ISOLATORS

00-06	Rear Coil Spring Isolator Kit	6-1705
-------	-------------------------------	--------

CONTROL ARM BUSHINGS, Front & Rear

00-06	Front C-Arm Bushing Kit	6-214
00-06	Rear C-Arm Bushing Kit	6-307
00-06	Rear Trailing Arm Bushing Kit	6-308

MOTOR MOUNT INSERTS

00-06	Motor Mount Insert Kit, Lower	6-502
-------	-------------------------------	-------

SWAY BAR BUSHINGS, Front & Rear

00-06	Front Sway Bar Bushing Kit, 21mm Bar	6-1152
00-06	Rear Sway Bar Bushing Kit, 20mm Bar	6-1153

TOTAL KITS

00-06	Total Kit	6-2026
-------	-----------	--------

Ford Mustang

BALL JOINT BOOTS

79-93	Ball Joint Boot Kits (2)	19-1723
94-04	Ball Joint Boot Kits (2)	19-1724

BUMP STOPS

64-73	Front Bump Stop Kit	6-1303-BL
-------	---------------------	-----------

CONTROL ARM BUSHINGS, FRONT

64-66	C-Arm Bushing Kit, w/o Shells (Lower Insert)	6-201
67-73	C-Arm Bushing Kit, w/o Shells (w/1.4375" O.D. Lower Insert)	6-202
67-73	C-Arm Bushing Kit, w/o Shells (w/1.5625" O.D. Lower Insert)	6-203
74-78	C-Arm Bushing Kit, w/o Shells	6-204
79-82	C-Arm Bushing Kit, w/o Shells (w/ Heavy Duty Suspension)	6-206
79-93	C-Arm Bushing Kit, w/o Shells (Except Heavy Duty Suspension)	6-205
79-93	C-Arm Bushing Kit, w/Shells (Except Heavy Duty Suspension)	6-209
84-86	C-Arm Bushing Kit, w/o Shells (SVO)	6-208
94-04	Front. C-Arm Bushings w/o Shells (w/Non-Hydro Lower Bushing)	6-207
96-04	Front "Hydro" C-Arm Bushing Kit w/o Shells	6-217
05-06	Front Control Arm Bushing Kit	6-218

CONTROL ARM BUSHINGS, REAR

79-93	C-Arm Bushing Kit, w/o Shells (w/ Round Bushing)	6-301
84-86	C-Arm Bushing Kit, w/o Shells (Mustang SVO)	6-303
79-98	C-Arm Bushing Kit, w/o Shells (Front Lower Oval Bushing)	6-302

FORD Mustang (Continued)

CONTROL ARM BUSHINGS, REAR

79-03	C-Arm Bushing Axle Housing Kit (Hard Durometer, w/o Shells)	6-309
99-04	C-Arm Bushing Kit, w/o Shells (Front Lower Oval Bushing)	6-306
99-04	Cobra I.R.S. C-Arm Bushing Kit w/o Shells	6-311
05-06	Control Arm Bushing Kit, Upper & Lower	6-312
05-06	Control Arm Bushing Kit, Lower Only	6-313
05-06	Control Arm Bushing Kit, Upper Only	6-314

DIFFERENTIAL BUSHINGS

99-04	Cobra I.R.S. Differential Bushing Kit, Front	6-1609
99-04	Cobra I.R.S. Differential Bushing Kit, Rear	6-1610
05-06	Differential Bushing Kit	6-315

MOTOR MOUNTS

Various (See Application Chart on Pages 13 & 14)

SHIFTER BUSHINGS

05-06	Shifter Bushing Kit	6-1611
-------	---------------------	--------

SPRING ISOLATORS, FRONT & REAR

64-73	Front Spring Isolator, Uppers Only	6-1704
79-82	Front Coil Spring Isolators, Uppers Only	6-1708
79-99	Rear Spring Isolators, Upper & Lower	6-1701
83-99	Front Spring Isolators, Upper & Lower	6-1703
99-04	Cobra I.R.S Spring Isolators, Lower Only	6-1709

SPRING PERCHES, FRONT

64-73	Front Spring Perch Pair, Lower	6-1702
-------	--------------------------------	--------

SPRING & SHACKLE, OEM & HD REAR

64-73	Spring Eye & Shackle Bushing Kit (1/2" Shackle Bolts)	6-1051
64-66	Spring Eye & Shackle Bushing Kit (9/16" Shackle Bolts)	6-1052
64-73	Spring Eye & HD Shackle Kit**	6-1053
64-73	Rear HD Shackle Kit Only*	6-1054

*Includes rear only eye bushings, shackle bushings, zinc plated heavy duty steel shackles, bolts and locknuts.

**Includes both spring eye bushings, shackle bushings, zinc plated heavy duty steel shackles, bolts and locknuts.

STEERING

64-70	Power Steering Ram Bushing Kit	6-705
74-78	Rack & Pinion Kit	6-701
79-9/84	Rack & Pinion Kit	6-702
10/84-02	Rack & Pinion Kit	6-703
10/84-02	Rack & Pinion Kit (Offset Style)*	6-704

*(For Lowered cars.)

STRUT ARM BUSHINGS

64-66	Strut Arm Bushing Kit	6-1204
67-73	Strut Arm Bushing Kit	6-1205
74-78	Strut Arm Bushing Kit	6-1206

STRUT TOWER BUSHINGS

83-04	McPherson Strut Tower Bushing Kit	6-1213
-------	-----------------------------------	--------



Ford Mustang (Continued)

SUBFRAME MOUNTS

79-98	IRS Subframe Bushing Kit	6-111
99-04	Cobra/Mustang IRS Subframe Bushing Kit	6-112

SWAY BAR BUSHINGS, FRONT

99-04	Sway Bar Bushings (See Page 8 For S/B Bushing Listings)	19-XXXX
79-04	Sway Bar Bushing Kit, 7/8" Bar	6-1120
79-04	Sway Bar Bushing Kit, 15/16" Bar	6-1121
79-04	Sway Bar Bushing Kit, 1" Bar	6-1122
79-04	Sway Bar Bushing Kit, 1-1/16" Bar	6-1123
79-04	Sway Bar Bushing Kit, 1-1/8" Bar	6-1124
79-04	Sway Bar Bushing Kit, 1-1/4" Bar	6-1125
79-04	Sway Bar Bushing Kit, 1-5/16" Bar	6-1126
79-04	Sway Bar Bushing Kit, 1-3/8" Bar	6-1133
79-04	Sway Bar Bushing Kit, 25mm Bar	6-1134
79-04	Sway Bar Bushing Kit, 27mm Bar	6-1135
79-04	Sway Bar Bushing Kit, 28mm Bar	6-1155
79-04	Sway Bar Bushing Kit, 29mm Bar	6-1136
79-04	Sway Bar Bushing Kit, 30mm Bar	6-1137
05-06	Sway Bar Bushing Kit, 28.6mm Bar	6-1164
05-06	Sway Bar Bushing Kit, 34mm Bar	6-1161

SWAY BAR BUSHINGS, REAR

99-04	Cobra Sway Bar Bushing Kit 25mm Bar	6-1157
05-06	Sway Bar Bushing Kit, w/End Links 20mm Bar	6-1162
05-06	Conv. V-6 Sway Bar Bushing Kit, w/End Links 18mm Bar	6-1163

SWAY BAR END LINKS, FRONT

64-66	End Link Kit	19-405
67-73	End Link Kit	19-408
79-93	End Link Kit	19-417
94-04	End Link Kit	19-416
79-04	Mustang O.E. Style Bushing Kit (8) (End Link Bushings Only)	19-431
84-86	Sway Bar End Link Kit (Mustang SVO)	19-417

TIE ROD BOOTS

64-66	Tie Rod Boot Kit (2)	19-1711
67-04	Tie Rod Boot Kit (2)	19-1712

TRACK BAR, REAR

05-06	Track Bar Bushing Kit	6-1219
-------	-----------------------	--------

TRANSMISSION MOUNTS

65-73	Trans. Mount Kit, (V8)	6-1605
79-84	Trans. Mount Kit, (6 Cylinder w/ Auto.)	6-1604
79-93	Trans. Crossmember to Frame Bushing Kit	6-1603
79-95	Trans. Mount Kit, GT (Manual)	6-1604
79-98	Trans. Mount Kit, GT (Automatic)	6-1604
96-98	Trans. Mount Kit, Cobra (Manual) (Does not fit 96-98 GT manual)	6-1604
79-98	Conversion Trans. Mount Kit (Tremec T56 6 spd. Requires Customer Fabrication)	6-1608
11/95-98	6 cyl. Auto. & Manual Transmission	6-1604
99-04	Trans. Mnt./X-member Combo Kit	6-1606
99-04	Trans. X-member (Requires 6-1605)	6-1607

Ford Mustang (Continued)

TOTAL KITS

65-66	Total Kit (w/o Trans. Mount)	6-2004
65-66	Total Kit (w/ Trans. Mount, V8)	6-2024
67-73	Total Kit (w/o Trans. Mount)	6-2001
79-82	Total Kit (w/o Trans. Mount)	6-2029
79-82	Total Kit (w/ Trans. Mount, V8 Auto & Man)*	6-2030
83-84	Total Kit (w/o Trans. Mount)	6-2031
83-84	Total Kit (w/ Trans. Mount, V8 Auto & Man)*	6-2032
85-93	Total Kit (w/o Trans. Mount)	6-2002
85-93	Total Kit (w/Trans. Mount, V8)	6-2005
94-98	Total Kit (w/o Trans. Mount)	6-2003
94-98	Total Kit (w/Trans. Mount, V8)**	6-2006
99-04	Total Kit (Except Cobra) (w/o Trans. Mount)	6-2025
99-04	Total Kit (Cobra) (w/o Trans. Mount)	6-2033
05-06	Total Kit (GT) (w/o Trans. Mount)	6-2034

* (6 Cyl. w/ Auto.) ** (Does Not Fit 96-98 GT Manual Trans.)

Ford Compact, Mid-Size & Full Size

CONTROL ARM BUSHINGS, FRONT

(Crown Victoria w/Police, Tow & Taxi Package)		
92-94	Front C-Arm Bushing Kit w/o Shells	6-215
95-97	Front C-Arm Bushing Kit w/o Shells	6-216
(Fairlane, Grand Torino, Torino, Elite & Ranchero)		
67-71	Front C-Arm Bushing Kit w/o Shells (Lower Insert 1.4375" O.D.)	6-202
67-71	Front C-Arm Bushing Kit w/o Shells (Lower Insert 1.5625" O.D.)	6-203
(Granada)		
75-80	Front C-Arm Bushing Kit w/o Shells (Lower insert 1.4375" O.D.)	6-202
75-80	Front C-Arm Bushing Kit w/o Shells (Lower insert 1.5625" O.D.)	6-203
(Fairlane, Grand Torino, Torino, Elite, Ranchero after 3/15/72)		
72-79	Front C-Arm Bushing Kit w/o Shells	6-210
(Full Size, Galaxie, Crown Victoria, Custom, LTD thru 82)		
72-78	Front C-Arm Bushing Kit w/o Shells	6-210

MOTOR MOUNTS

Various (See Application Chart on Page 13)

STEERING

(Fairlane, Grand Torino, Torino, Elite)		
65-71	Power Steering Ram Bushing Kit	6-705
(Maverick)		
70-72	Power Steering Ram Bushing Kit	6-705

STRUT ARM BUSHINGS

(Falcon/Ranchero)		
60-66	Strut Arm Bushing Kit	6-1204
(Fairlane)		
62-66	Strut Arm Bushing Kit	6-1204
67-71	Strut Arm Bushing Kit	6-1205



Ford Compact, Mid-Size & Full Size (Continued)

STRUT ARM BUSHINGS (Continued)

<i>(Fairlane, Grand Torino, Torino, Elite, Ranchero after 3/15/72)</i>		
72-79	Strut Arm Bushing Kit	6-1216
<i>(Full Size, Galaxie, Crown Victoria, Custom, LTD thru 82)</i>		
65-78	Strut Arm Bushing Kit	6-1216
<i>(Granada)</i>		
75-80	Strut Arm Bushing Kit	6-1205
<i>(Pinto)</i>		
74-80	Strut Arm Bushing Kit	6-1206
<i>(Taurus)</i>		
86-95	Strut Arm Bushing Kit (Front)	6-1214
86-95	Strut Arm Bushing Kit (Rear)	6-1215

SWAY BAR BUSHINGS, FRONT

<i>(Escort)</i>		
90-96	Sway Bar Bushing Kit, 3/4" Bar	6-1149
90-96	Sway Bar Bushing Kit, 15/16" Bar	6-1150
<i>(Taurus)</i>		
86-95	Sway Bar Bushings	19-XXXX

(See Page 8 For S/B Bushing Listings)

SWAY BAR BUSHINGS, REAR

<i>(Escort)</i>		
90-96	Sway Bar Bushing Kit, 3/4" Bar	6-1149
<i>(Taurus)</i>		
86-95	Sway Bar Bushing Kit, 20mm Bar*	6-1139
86-95	Sway Bar Bushing Kit, 1" Bar*	6-1140
86-95	Sway Bar Bushing Kit, 1-1/16" Bar*	6-1141
86-95	Sway Bar Bushing Kit, 1-1/8" Bar*	6-1142

**(Includes End Link Bushings)*

SWAY BAR END LINKS, Front & Rear

<i>(AC Cobra)</i>		
62-67	End Link Kit	19-405
<i>(Escort)</i>		
90-96	End Link Kit (Front)	4-401
90-96	End Link Kit (Rear)	6-401
<i>(Fairmont)</i>		
78-82	End Link Kit	19-417
<i>(Fairlane, Grand Torino, Elite &, Ranchero after 3/15/72)</i>		
67-71	End Link Kit	19-405
72-79	End Link Kit	19-409
<i>(Galaxie, Crown Victoria & Custom, LTD thru 82)</i>		
72-78	End Link Kit	19-409
83-88	End Link Kit (LTD w/o Tow Pkg)	19-417
<i>(Granada)</i>		
75-80	End Link Kit	19-405
81-82	End Link Kit	19-417
<i>(Maverick)</i>		
70-77	End Link Kit	19-408

TIE ROD BOOTS

62-95	Tie Rod Boot Kit (2)	19-1712
-------	----------------------	---------

Ford Compact, Mid-Size & Full Size (Continued)

TRANSMISSION MOUNTS

65-68	Transmission Mount (Fairlane)	6-1605
62-70	Transmission Mount (Falcon)	6-1605
75-80	Transmission Mount (Granada)	6-1605
65-77	Transmission Mount (Maverick)	6-1605
68-76	Transmission Mount (Torino)	6-1605

Ford Thunderbird

CONTROL ARM BUSHINGS, FRONT

80-86	C-Arm Bushing Kit, w/ Shells (Except Heavy Duty Suspension)	6-209
80-86	C-Arm Bushing Kit, w/o Shells (Except Heavy Duty Suspension)	6-205
80-86	C-Arm Bushing Kit, w/o Shells (w/ Heavy Duty Suspension)	6-206
87-88	C-Arm Bushing Kit, w/o Shells	6-211

CONTROL ARM BUSHINGS, REAR

80-88	C-Arm Bushing Kit, w/o Shells (w/ Round Bushing)	6-301
80-88	C-Arm Bushing Kit, w/o Shells (Front Lower Oval Bushing)	6-302

MOTOR MOUNTS

80-85	Motor Mount Kit (w/5.0 Engine) Pair	6-501
-------	-------------------------------------	-------

STEERING

80-9/84	Rack & Pinion Kit	6-702
10/84-88	Rack & Pinion Kit	6-703

STRUT ARM BUSHINGS

72-79	Front Strut Arm Bushing Kit	6-1216
-------	-----------------------------	--------

SWAY BAR BUSHINGS, FRONT

80-88	Sway Bar Bushing Kit, 7/8" Bar	6-1120
80-88	Sway Bar Bushing Kit, 15/16" Bar	6-1121
80-88	Sway Bar Bushing Kit, 1" Bar	6-1122
80-88	Sway Bar Bushing Kit, 1-1/16" Bar	6-1123
80-88	Sway Bar Bushing Kit, 1-1/8" Bar	6-1124
80-88	Sway Bar Bushing Kit, 1-1/4" Bar	6-1125
80-88	Sway Bar Bushing Kit, 1-5/16" Bar	6-1126

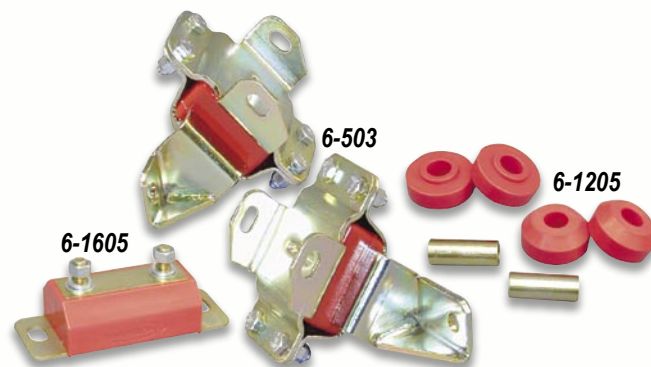

Ford Thunderbird (Continued)

SWAY BAR BUSHINGS, REAR

89-97	Sway Bar Bushing Kit, 25mm Bar*	6-1147
89-97	Sway Bar Bushing Kit, 27mm Bar* *(Includes End Link Bushings)	6-1148

SWAY BAR END LINKS, FRONT

72-79	End Link Kit	19-409
80-82	End Link Kit	19-417
83-88	End Link Kit	19-412

TIE ROD BOOTS

72-97	Tie Rod Boot Kit (2)	19-1712
-------	----------------------	---------

TRANSMISSION MOUNTS

80-84	Transmission Mount Kit, 6 cyl. w/Auto Trans	6-1604
80-88	Transmission Mount Kit, V-8 All	6-1604

Ford Full Size Trucks

AXLE PIVOT BUSHINGS

(F100, F150 2WD)

65-79	Axle Pivot Bushing Kit (With Twin I-Beam)	6-604
80-7/81	Axle Pivot Bushing Kit (Cast Axle)	6-603
8/81-5/83	Axle Pivot Bushing Kit (Stamped Axle)	6-601
6/83-86	Axle Pivot Bushing Kit (Cast Axle)	6-603
87-96	Axle Pivot Bushing Kit (Cast Axle)	6-605

(F250, F350 2WD)

65-79	Axle Pivot Bushing Kit, F250 (w/Twin I-Beam Exc. H/D)	6-604
75-79	Axle Pivot Bushing Kit, F350 (w/Twin I-Beam)	6-604
80-86	Axle Pivot Bushing Kit, F250 & F350	6-603
87-89	Axle Pivot Bushing Kit, F250 & F350	6-605
90-98	Axle Pivot Bushing Kit, F250 & F350	6-603

Ford Full Size Trucks (Continued)

AXLE PIVOT BUSHINGS

(Explorer 2WD)

91-94	Axle Pivot Bushing Kit	6-605
-------	------------------------	-------

(F100, F150, F250 & Bronco- 4WD)

80-96	Axle Pivot Bushing Kit	6-601
-------	------------------------	-------

(F350 4WD)

80-87	Axle Pivot Bushing Kit	6-601
-------	------------------------	-------

(Explorer 4WD)

91-94	Axle Pivot Bushing Kit	6-601
-------	------------------------	-------

(All Kits Include Inserts & Inner Sleeves)

BODY & CAB MOUNTS, 2WD & 4WD

(Bronco 2WD & 4WD)

66-77	16 Bushing Kit	6-101
-------	----------------	-------

66-77	Hardware Kit For #6-101	6-102
-------	-------------------------	-------

78-79	20 Bushing Kit	6-103
-------	----------------	-------

80-96	20 Bushing Kit	6-107
-------	----------------	-------

(F100, F150, F250, F350 2WD & 4WD)

66-79	12 Bushing Kit (4WD)	6-105
-------	----------------------	-------

66-79	12 Bushing Kit (2WD)	6-110
-------	----------------------	-------

80-96	12 Bushing Kit (2WD & 4WD)	6-108
-------	----------------------------	-------

(F150, F250LD 2WD & 4WD)

97-03	Body Mount Kit (Standard Cab)	6-113
-------	-------------------------------	-------

97-03	Body Mount Kit (Extended Cab)	6-114
-------	-------------------------------	-------

97-03	Body Mount Kit (Crew Cab)	6-115
-------	---------------------------	-------

C-BUSHINGS, RADIUS ARM BUSHINGS, TRACK ARM BUSHINGS

(F100, F150, Bronco 2WD & 4WD)

66-79	C-Bush. Only-4 Pc. Kit-2° Offset (Stock to 2" Lift)	6-1201
-------	---	--------

66-79	C-Bush. Only-4 Pc. Kit-4° Offset (2" to 4" Lift)	6-1202
-------	--	--------

66-79	C-Bush. Only-4 Pc. Kit-7° Offset (4" or More)	6-1203
-------	---	--------

66-79	Radius Arm Bushing Kit	6-1207
-------	------------------------	--------

80-92	Radius Arm Bushing Kit	6-1209
-------	------------------------	--------

80-1/92	Radius Arm Bushing Kit (Bronco)	6-1209
---------	---------------------------------	--------

2/92-96	Radius Arm Bushing Kit (Bronco)	6-1210
---------	---------------------------------	--------

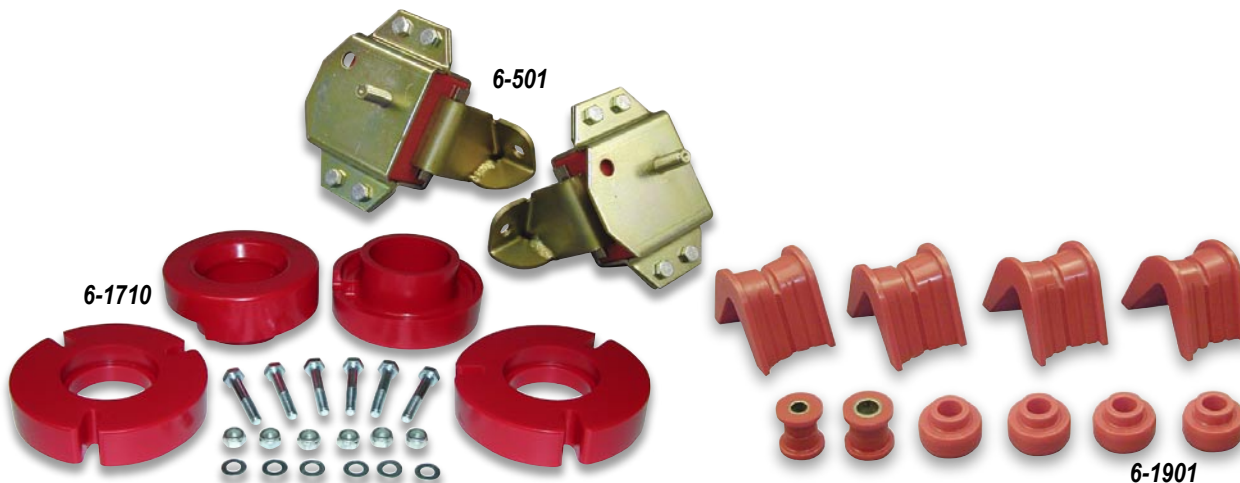

Ford Full Size Trucks (Continued)

C-BUSHINGS, RADIUS ARM BUSHINGS, TRACK ARM BUSHINGS (Cont.)

93-96	Radius Arm Bushing Kit	6-1210
66-79	Track Arm Bushing Kit - Round Type	6-1208
76-77	Track Arm Bushing Kit - Oval Type (Bronco)	6-1211
66-79	Complete 14-Piece Bushing Kit - 2° Offset	6-1901
66-79	Complete 14-Piece Bushing Kit - 4° Offset	6-1902
66-79	Complete 14-Piece Bushing Kit - 7° Offset	6-1903
(F250, F350 2WD & 4WD)		
65-79	Radius Arm Bushing Kit (2WD Only) (F250)	6-1207
80-92	Radius Arm Bushing Kit (2WD Only)	6-1209
93-98	Radius Arm Bushing Kit (2WD Only)	6-1210
85-98	Track Arm Bushing Kit (4WD Only) (F350)	6-1212
85-98	Track Arm Bushing Kit (2WD Only) (F350, F450 Super Duty /Solid Axle)	6-1212

(F250, F350 Super Duty 4WD)

99	Front Track Bar Bushing Kit	6-1217
00-03	Front Track Bar Bushing Kit	6-1218

(Excursion 4WD)

00-05	Front Track Bar Bushing Kit, (w/15.5mm Eyelets)	6-1217
00-05	Front Track Bar Bushing Kit, (w/21.5mm Eyelets)	6-1218

(Explorer 2WD & 4WD)

83-94	Strut Arm Bushing Kit	6-1210
-------	-----------------------	--------

COIL SPRING LIFT SPACERS

(F-150 2WD)

97-03	Front Coil Spring Lift Kit, 1.5" Lift	6-1707
-------	---------------------------------------	--------

(F-150 2WD & 4WD)

04-05	Front Coil Spring Lift Kit, 2.5" Lift	6-1710
-------	---------------------------------------	--------

(Expedition 2WD & 4WD)

03-04	Front Coil Spring Lift Kit, 2.5" Lift	6-1710
-------	---------------------------------------	--------

CONTROL ARM BUSHINGS, FRONT

97-03	C-Arm Bushing Kit (F150 2WD)	6-212
97-99	C-Arm Bushing Kit (F250 2WD Light Duty)	6-212
97-03	C-Arm Bushing Kit (F150, F250 4WD Light Duty)	6-219
99-03	C-Arm Bushing Kit (F150 Lightning)	6-212
97-02	C-Arm Bushing Kit (Expedition 2WD)	6-212
98-03	C-Arm Bushing Kit (Navigator 2WD)	6-212
95-01	C-Arm Bushing Kit (Explorer 2 & 4WD)	6-213

SPRING & SHACKLE BUSHINGS, FRONT

(F250 4WD)

67-77	Spring Eye & Shackle Bushing Kit w/1-1/4" OD Main Eye	6-1009
-------	---	--------

73-77	Spring Eye & Shackle Bushing Kit w/1-1/2" OD Main Eye Before Serial #Y20,001	6-1010
-------	--	--------

(Does Not Fit Crew Cab)

77-79	Spring Eye & Shackle Bushing Kit From Serial #Y20,001	6-1011
-------	---	--------

(Does Not Fit Crew Cab)

67-79	Frame Shackle Bushing Kit	6-801
-------	---------------------------	-------

(F250, F350 4WD)

80-98	Spring Eye & Shackle Bushing Kit w/2" OD Spring Eye	6-1012
-------	---	--------

80-98	Frame Shackle Bushing Kit	6-802
-------	---------------------------	-------

(F350 Super Duty 2WD)

80-98	Spring Eye & Shackle Bushing Kit	6-1013
-------	----------------------------------	--------

Ford Full Size Trucks (Continued)

(F350 Super Duty 2WD)

80-98	Frame Shackle Bushing Kit	6-802
-------	---------------------------	-------

SPRING & SHACKLE BUSHINGS, REAR 2WD

(F100, F150 2WD)

57-72	Spring Eye & Shackle Bushing Kit	6-1001
57-72	Frame Shackle Bushing Kit	6-803

(F100, F150 2WD)

68-72	Spring Eye w/3 Bushing Shackle Kit	6-1023
68-72	3 Bushing, Frame Shackle Bushing Kit	6-812
73-79	Spring Eye & Shackle Bushing Kit	6-1002
73-79	Frame Shackle Bushing Kit	6-807
80-81	Spring Eye & Shackle Bushing Kit (F100)	6-1003
80-81	Frame Shackle Bushing Kit (F100)	6-807
80-81	Spring Eye & Shackle Bushing Kit (F150)	6-1002
80-81	Frame Shackle Bushing Kit (F150)	6-807
82-96	Spring Eye & Shackle Bushing Kit	6-1017
82-96	Frame Shackle Bushing Kit	6-805
97-03	Spring Eye & Shackle Bushing Kit	6-1024

(F250 Except Crew Cab 2WD)

68-72	Spring Eye w/3 Bushing Shackle Kit	6-1022
68-72	3 Bushing, Frame Shackle Bushing Kit	6-812
73-79	Spring Eye & Shackle Bushing Kit	6-1004
73-79	Frame Shackle Bushing Kit	6-804

(F250 Crew Cab & F350 Except Super Cab)

73-79	Spring Eye w/o Frame Shackle Bushing Kit	6-1005
-------	--	--------

(F350 Super Cab-2WD)

73-79	Spring Eye & Shackle Bushing Kit	6-1006
73-79	Frame Shackle Bushing Kit	6-809

(F250 & F350 Except F350 Chassis Cab)

80-98	Spring Eye & Shackle Bushing Kit	6-1007
80-98	Frame Shackle Bushing Kit	6-806
80-98	Spring Eye & Shackle Bushing Kit (Molded In Frame Shackles)	6-1020
80-98	Frame Shackle Bushing Kit (Molded In Frame Shackles)	6-811

(E250, E350 2WD Van)

92-98	Spring Eye & Shackle Bushing Kit	6-1021
-------	----------------------------------	--------

(Explorer 2WD)

91-94	Spring Eye & Shackle Bushing Kit	6-1019
91-94	Frame Shackle Bushing Kit	6-810

SPRING & SHACKLE BUSHINGS, REAR 4WD

(F100, F150 4WD)

66-72	Spring Eye & Shackle Bushing Kit	6-1008
66-72	Frame Shackle Bushing Kit	6-803
73-79	Spring Eye & Shackle Bushing Kit	6-1004
73-79	Frame Shackle Bushing Kit	6-804
80-96	Spring Eye & Shackle Bushing Kit	6-1007
80-96	Frame Shackle Bushing Kit	6-806
80-96	Spring Eye & Shackle Bushing Kit (Molded In Frame Shackles)	6-1020
80-96	Frame Shackle Bushing Kit (Molded In Frame Shackles)	6-811



Ford Full Size Trucks (Continued)

SPRING & SHACKLE BUSHINGS, Rear 4WD (Continued)

97-03	Spring Eye & Shackle Bushing Kit (F250, F350 4WD)	6-1024
73-77	Spring Eye & Shackle Bushing Kit	6-1003
73-77	Frame Shackle Bushing Kit (F250, F350 4WD)	6-807
77-79	Spring Eye & Shackle Bushing Kit (w/ 3" wide springs)	6-1004
77-79	Frame Shackle Bushing Kit	6-804
80-98	Spring Eye & Shackle Bushing Kit	6-1007
80-98	Frame Shackle Bushing Kit	6-806
80-98	Spring Eye & Shackle Bushing Kit (Molded In Frame Shackles)	6-1020
80-98	Frame Shackle Bushing Kit (Molded In Frame Shackles)	6-811
(Bronco 4WD)		
66-77	Spring Eye & Shackle Bushing Kit	6-1008
66-77	Frame Shackle Bushing Kit	6-803
78-79	Spring Eye & Shackle Bushing Kit	6-1004
78-79	Frame Shackle Bushing Kit	6-804
80-96	Spring Eye & Shackle Bushing Kit	6-1007
80-96	Frame Shackle Bushing Kit	6-806
80-96	Spring Eye & Shackle Bushing Kit (Molded In Frame Shackles)	6-1020
80-96	Frame Shackle Bushing Kit (Molded In Frame Shackles)	6-811
(Explorer 4WD)		
91-94	Spring Eye & Shackle Bushing Kit	6-1019
91-94	Frame Shackle Bushing Kit	6-810

SWAY BAR BUSHINGS, FRONT & REAR

(F150, 2WD)(F250, 2WD LD to '99)		
97-03	Front Sway Bar Bushing Kit, 30mm Bar*	6-1130
(F150, 4WD)(F250, 4WD LD to '99)		
97-02	Front Sway Bar Bushing Kit, 27mm Bar*	6-1154
(F150, 2WD & 4WD)		
04-05	Front Sway Bar Bushing Kit, 34mm Bar (F350 4WD)	6-1158
88-94	Front Sway Bar Bushing Kit, 1-1/8" Bar*	6-1146
(Van E250, E350)		
92-00	Front Sway Bar Bushing Kit, 1" Bar*	6-1151
(Explorer 2WD & 4WD)		
91-94	Front Sway Bar Bushing Kit, 23mm Bar*	6-1108
91-94	Rear Sway Bar Bushing Kit, 16mm Bar*	6-1114
95-01	Front Sway Bar Bushing Kit, 1.430" Bar*	6-1131
95-01	Rear Sway Bar Bushing Kit, .765" Bar*	6-1132
02-04	Front Sway Bar Bushing Kit, 30mm Bar	6-1159
02-04	Rear Sway Bar Bushing Kit, 21mm Bar	6-1160
(Expedition 2WD & 4WD, Navigator 2WD & 4WD)		
97-03	Front Sway Bar Bushing Kit, 33mm Bar 4WD*	6-1138
97-03	Rear Sway Bar Bushing Kit, 22mm Bar 4WD*	6-1143
97-03	Front Sway Bar Bushing Kit, 32mm Bar 2WD*	6-1144
97-03	Rear Sway Bar Bushing Kit, 21mm Bar 2WD*	6-1145

*Includes End Link Bushings

Ford Full Size Trucks (Continued)

FRONT OR REAR SWAY BAR WITH 2" TALL FRAME BUSHINGS & STUD END TO EYE BOLT END LINKS

(F100, F150, F250, F350, Bronco 2WD & 4WD)		
70-98	Sway Bar Bushing Kit, 5/8" Bar	6-1109
70-98	Sway Bar Bushing Kit, 3/4" Bar	6-1110
70-98	Sway Bar Bushing Kit, 7/8" Bar	6-1111
70-98	Sway Bar Bushing Kit, 1" Bar	6-1112
70-98	Sway Bar Bushing Kit, 1-1/8" Bar	6-1113

FRONT OR REAR SWAY BAR WITH 2" TALL FRAME BUSHINGS & EYE BOLT TO EYE BOLT END LINKS

(F100, F150, F250, F350, Bronco 2WD & 4WD)		
70-98	Sway Bar Bushing Kit, 5/8" Bar	6-1114
70-98	Sway Bar Bushing Kit, 3/4" Bar	6-1115
70-98	Sway Bar Bushing Kit, 7/8" Bar	6-1116
70-98	Sway Bar Bushing Kit, 1" Bar	6-1117
70-98	Sway Bar Bushing Kit, 1-1/8" Bar	6-1118

FRONT OR REAR SWAY BAR WITH 2-1/2" TALL FRAME BUSHINGS & STUD END TO EYE BOLT END LINKS

(F100, F150, F250, F350, Bronco 2WD & 4WD)		
75-98	Sway Bar Bushing Kit, 7/8" Bar	6-1101
75-98	Sway Bar Bushing Kit, 1" Bar	6-1102
75-98	Sway Bar Bushing Kit, 1-1/8" Bar	6-1103

FRONT OR REAR SWAY BAR WITH 2-1/2" TALL FRAME BUSHINGS & EYE BOLT TO EYE BOLT END LINKS

(F100, F150, F250, F350, Bronco 2WD & 4WD)		
77-98	Sway Bar Bushing Kit, 7/8" Bar	6-1104
77-98	Sway Bar Bushing Kit, 1" Bar	6-1105
77-98	Sway Bar Bushing Kit, 1-1/8" Bar	6-1106

FRONT OR REAR SWAY BAR WITH 3-1/2" TALL FRAME BUSHINGS & EYE BOLT TO EYE BOLT END LINKS

(F100, F150, F250, F350, Bronco 2WD & 4WD)		
70-98	Sway Bar Bushing Kit, 7/8" Bar	6-1127
70-98	Sway Bar Bushing Kit, 23mm Bar	6-1108
70-98	Sway Bar Bushing Kit, 1" Bar	6-1128
70-98	Sway Bar Bushing Kit, 1-1/8" Bar	6-1129

TIE ROD BOOTS

65-98	Tie Rod Boot Kit (2)	19-1712
-------	----------------------	---------

TRANSFER CASE MOUNTS

(F150, F250, Bronco 4WD)		
To 76	Transfer Case Mount Kit (F150 & F250)	6-1601
66-77	Transfer Case Mount Kit (Bronco)	6-1602

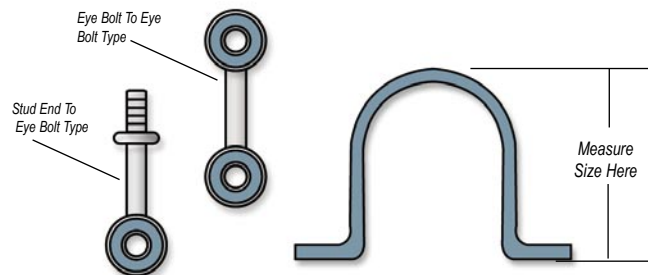

Ford Full Size Trucks (Continued)

TOTAL KITS

<i>(Bronco)</i>		
66-77	Total Kit	6-2016
<i>(F100, F150 2WD)</i>		
66-79	Total Kit*	6-2020
<i>(F150, 4WD)</i>		
73-79	Total Kit	6-2017
80-96	Total Kit	6-2018
<i>(F250 4WD)</i>		
80-98	Total Kit	6-2027
<i>(F150 2WD)</i>		
87-96	Total Kit	6-2028
97-03	Total Kit (Standard, Extended & Crew Cab)	6-2035
<i>(F150/F250LD 4WD)</i>		
97-03	Total Kit (Standard, Extended & Crew Cab)	6-2036
<i>(Explorer 4WD)</i>		
91-94	Total Kit	6-2019
	*Does Not Fit Trucks With 3 Bushing Shackles	



Ford Trucks, Ranger & Bronco II

AXLE PIVOT BUSHINGS

(2WD)		
83-97	Axle Pivot Bushing Kit, w/o Shells	6-605
(Ranger 4WD)		
83-97	Axle Pivot Bushing Kit, w/o Shells	6-601
(Bronco II 4WD)		
84-90	Axle Pivot Bushing Kit, w/o Shells	6-601

BODY & CAB MOUNTS, 2WD & 4WD

(Ranger 2WD & 4WD)		
83-97	12 Bushing Kit	6-106
(Bronco II 2WD & 4WD)		
84-88	20 Bushing Kit	6-104

CONTROL ARM BUSHINGS, FRONT

(Ranger 2WD & 4WD)		
98-02	Front C-Arm Bushing Kit, w/o Shells	6-213

STRUT BUSHINGS

(2WD & 4WD)		
84-97	Strut Arm Bushing Kit	6-1210

SPRING & SHACKLE BUSHINGS, REAR

(2WD & 4WD)		
83-85	Spring Eye & Shackle Bushing Kit (w/Plastic Frame Shackles)	6-1017
83-85	Frame Shackle Bushing Kit	6-805
83-88	Spring Eye & Shackle Bushing Kit (w/Common Frame Shackles)	6-1003
83-88	Frame Shackle Bushing Kit	6-807
86-97	Spring Eye & Shackle Bushing Kit (w/Molded-In Frame Shackles)	6-1018
86-97	Frame Shackle Bushing Kit	6-808

SWAY BAR BUSHINGS, FRONT

(2WD & 4WD)		
83	1/2-89 Sway Bar Bushing Kit, 1-1/8" Bar (Trucks Not Equipped With Front End Links)	6-1107

FRONT OR REAR SWAY BAR WITH 2" TALL FRAME BUSHINGS & STUD END TO EYE BOLT END LINKS

(2WD & 4WD)		
83-97	Sway Bar Bushing Kit, 5/8" Bar	6-1109
83-97	Sway Bar Bushing Kit, 3/4" Bar	6-1110
83-97	Sway Bar Bushing Kit, 7/8" Bar	6-1111
83-97	Sway Bar Bushing Kit, 1" Bar	6-1112
83-97	Sway Bar Bushing Kit, 1-1/8" Bar	6-1113

FRONT OR REAR SWAY BAR WITH 2" TALL FRAME BUSHINGS & EYE BOLT TO EYE BOLT END LINKS

(2WD & 4WD)		
83-97	Sway Bar Bushing Kit, 5/8" Bar	6-1114
83-97	Sway Bar Bushing Kit, 3/4" Bar	6-1115
83-97	Sway Bar Bushing Kit, 7/8" Bar	6-1116
83-97	Sway Bar Bushing Kit, 1" Bar	6-1117
83-97	Sway Bar Bushing Kit, 1-1/8" Bar	6-1118

Ford Trucks, Ranger & Bronco II (Continued)

FRONT OR REAR SWAY BAR WITH 2-1/2" TALL FRAME BUSHINGS & STUD END TO EYE BOLT END LINKS

(2WD & 4WD)		
83-97	Sway Bar Bushing Kit, 7/8" Bar	6-1101
83-97	Sway Bar Bushing Kit, 1" Bar	6-1102
83-97	Sway Bar Bushing Kit, 1-1/8" Bar	6-1103

FRONT OR REAR SWAY BAR WITH 2-1/2" TALL FRAME BUSHINGS & EYE BOLT TO EYE BOLT END LINKS

(2WD & 4WD)		
83-97	Sway Bar Bushing Kit, 7/8" Bar	6-1104
83-97	Sway Bar Bushing Kit, 1" Bar	6-1105
83-97	Sway Bar Bushing Kit, 1-1/8" Bar	6-1106

FRONT OR REAR SWAY BAR WITH 3-1/2" TALL FRAME BUSHINGS & EYE BOLT TO EYE BOLT END LINKS

(2WD & 4WD)		
83-97	Sway Bar Bushing Kit, 7/8" Bar	6-1127
83-97	Sway Bar Bushing Kit, 23mm Bar	6-1108
83-97	Sway Bar Bushing Kit, 1" Bar	6-1128
83-97	Sway Bar Bushing Kit, 1-1/8" Bar	6-1129

TIE ROD BOOTS

(Ranger 2WD & 4WD, Bronco II 4WD)		
83-02	Tie Rod Boot Kit (2)	19-1712

TOTAL KITS

83-97	Total Kit (Ranger, 2WD STD & Extra Cab)	6-2021
83-97	Total Kit (Ranger, 4WD STD & Extra Cab)	6-2022
84-88	Total Kit (Bronco II, 4WD)	6-2023

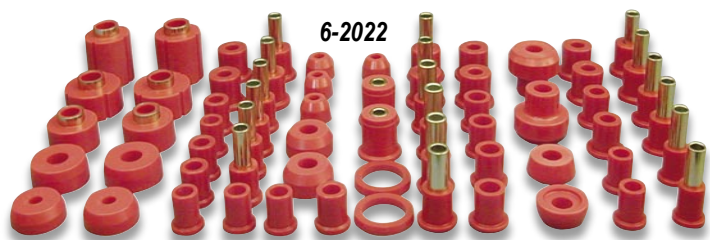
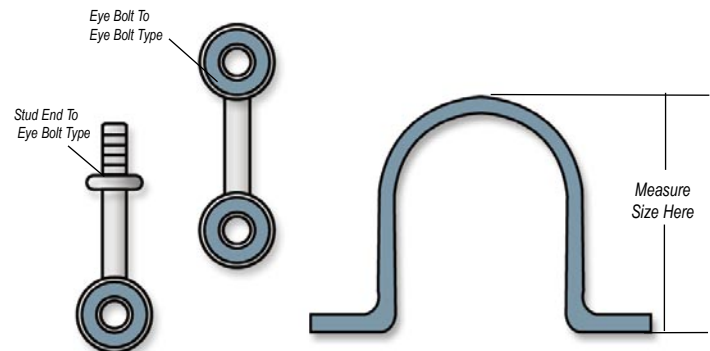

Honda

BALL JOINT BOOTS

84-87	Front Ball Joint Boot Kit (2) (Civic/CRX) (2 kits required.)	19-1712
88-00	Front Ball Joint Boot Kit (4) (Civic/CRX/Del Sol)	8-1701
90-97	Front Ball Joint Boot Kit (4) (Accord)	8-1702

CONTROL ARM BUSHINGS, FRONT

(Accord)

86-89	Lower Control Arm Bushing Kit	8-210
90-93	Control Arm Bushing Kit, Upper & Lower	8-204
90-93	Lower Control Arm Bushing Kit	8-214
94-97	Control Arm Bushing Kit, Upper & Lower	8-205
90-97	Upper Control Arm Bushing Kit	8-213
94-97	Lower Control Arm Bushing Kit	8-216

(Civic/CRX/Del Sol**)

84-87	Lower Control Arm Bushing Kit	8-201
88-91	Control Arm Bushing Kit, Upper & Lower	8-202
88-91	Upper Control Arm Bushing Kit	8-209
88-91	Lower Control Arm Bushing Kit	8-210
92-95	Control Arm Bushing Kit, Upper & Lower	8-203
92-95	Upper Control Arm Bushing Kit	8-211
92-95	Lower Control Arm Bushing Kit	8-212
96-00	Control Arm Bushing Kit, Upper & Lower	8-218
96-00	Upper Control Arm Bushing Kit	8-219
96-00	Lower Control Arm Bushing Kit	8-220
01-05	Lower Control Arm Bushing Kit	8-215

**For 93-97 Del Sol use 92-95 Civic listings

(Civic SI)

99-00	Control Arm Bushing Kit, Upper & Lower	8-221
99-00	Upper Control Arm Bushing Kit	8-219
99-00	Lower Control Arm Bushing Kit	8-222

(Prelude)

92-96	Control Arm Bushing Kit, Upper & Lower	8-205
-------	--	-------

CONTROL ARM BUSHINGS, REAR

(Accord)

86-89	Lower Control Arm Bushing Kit	8-312
90-97	Control Arm Bushing Kit, Upper & Lower	8-313
90-97	Upper Control Arm Bushing Kit	8-311
90-97	Lower Control Arm Bushing Kit	8-312

(Civic/CRX/Del Sol**)

84-87	Control Arm Bushing Kit	8-301
88-95	Control Arm Bushing Kit, Upper & Lower	8-305
88-00	Upper Control Arm Bushing Kit	8-307
88-95	Lower Control Arm Bushing Kit	8-302
96-00	Control Arm Bushing Kit, Upper & Lower	8-306
96-00	Lower Control Arm Bushing Kit	8-308
88-00	Compensator Arm Bushing Kit	8-309
01-05	Control Arm Bushing Kit, Upper & Lower	8-318

**For 93-97 Del Sol use 92-95 Civic listings

(Civic SI)

99-00	Control Arm Bushing Kit, Upper & Lower	8-306
99-00	Upper Control Arm Bushing Kit	8-307
99-00	Lower Control Arm Bushing Kit	8-308
99-00	Compensator Arm Bushing Kit	8-309

Honda (Continued)

CONTROL ARM BUSHINGS, REAR (Continued)

(Prelude)

92-96	Control Arm Bushing Kit, Upper & Lower	8-315
-------	--	-------

MOTOR MOUNT INSERTS

(Accord)

90-97	Engine Mount Insert Kit, (Rear)	8-514
94-97	Engine Mount Insert Kit, (Front)	8-515
94-97	Front & Rear Engine Mount Kit	8-1907

(Civic/CRX)

88-91	Engine Mount Insert Kit (Left Upper)	8-506
88-91	Trans Mount Insert Kit (Right Upper)	8-507
88-91	Firewall Mount Insert Kit (Rear)	8-508
88-91	Engine Mount Insert Kit (Front)	8-517
88-91	All 4 Mounts Kit	8-1903

(Civic/Del Sol)

92-95	Engine Mount Insert Kit (Left Upper) (1.6 Ltr.) (Exc. 92-93 SI)	8-501
92-95	Trans Mount Insert Kit (Right Upper)	8-502
92-95	Firewall Mount Insert Kit (Rear)	8-503
92-95	All 3 Mounts Kit (1.6 Ltr.) (Exc. 92-93 SI)	8-1901

(Civic)

96-00	Engine Mount Insert Kit (Left Upper)	8-504
96-00	Trans Mount Insert Kit (Right Upper)	8-505
96-00	Firewall Mount Insert Kit (Rear)	8-503
96-00	All 3 Mounts Kit	8-1902

(Civic SI)

99-00	Engine Mount Insert Kit (Left Upper)	8-504
99-00	Trans Mount Insert Kit (Right Upper)	8-505
99-00	Firewall Mount Insert Kit (Rear)	8-509
99-00	All 3 Mounts Kit	8-1906

REAR TRAILING ARM BUSHINGS

(Civic, CRX, Del Sol)

88-00	Rr. Trailing Arm Bushing Kit	8-304
-------	------------------------------	-------

(Prelude)

92-96	Rr. Trailing Arm Bushing Kit	8-316
-------	------------------------------	-------

SHIFTER STABILIZER BUSHINGS

(Civic/CRX/Del Sol)

84-87	Shifter Stabilizer Bushing Kit (Civic/CRX)	8-1601
88-00	Shifter Stabilizer Bushing Kit (Civic/CRX)	8-1602
99-00	Shifter Stabilizer Bushing Kit (Civic SI)	8-1601
93-97	Shifter Stabilizer Bushing Kit (Del Sol VTEC)	8-1601
93-97	Shifter Stabilizer Bushing Kit (Del Sol non VTEC)	8-1602

SHOCK BUSHINGS

(Accord)

86-89	Front Lower Shock Bushing Kit	8-907
90-97	Front Shock Bushing Kit*	8-903

(Civic/CRX/Del Sol**)

88-00	Front Shock Bushing Kit*	8-901
88-95	Rear Shock Bushing Kit*	8-902
96-00	Rear Shock Bushing Kit (Civic)*	8-904

**For 93-97 Del Sol use 92-95 Civic listings

*Kit Includes Fork Bushings



Honda (Continued)

SHOCK BUSHINGS (Continued)

<i>(Civic SI)</i>		
99-00	Front Shock Bushing Kit*	8-905
99-00	Rear Shock Bushing Kit*	8-904
<i>(Prelude)</i>		
92-00	Front Shock Bushing Kit*	8-903
92-96	Rear Shock Bushing Kit*	8-906
	*Kit Includes Fork Bushings	

SPRING ISOLATORS

<i>(Accord)</i>		
90-97	Front Coil Spring Isolator Kit (Upper)	8-1703
<i>(Prelude)</i>		
92-00	Front Coil Spring Isolator Kit (Upper)	8-1703

STEERING

<i>(Civic/CRX/Del Sol)</i>		
88-91	Rack & Pinion Bushing Kit (P/S Only)	8-701
92-95	Rack & Pinion Bushing Kit (P/S Only)	8-702

STRUT ROD BUSHINGS

86-89	Front Strut Rod Bushing Kit (Accord)	8-1201
88-91	Front Strut Rod Bushing Kit (Civic/CRX)	8-1201
90-97	Front Strut Rod Bushing Kit (Accord)	8-1202
92-00	Front Strut Rod Bushing Kit (Prelude)	8-1202

SWAY BAR & END LINKS, FRONT

<i>(Accord)</i>		
86-89	End Link Kit	8-401
90-97	Sway Bar Bushing Kit, 25mm Bar	8-1113
90-97	End Link Kit	8-402
90-97	8 Piece OEM Style Bushing Kit	8-403
94-97	Sway Bar Bushing Kit, 22mm Bar	8-1115
98-02	Sway Bar Bushing Kit, 26.5mm (4 cyl. Only)	8-1127
98-02	Sway Bar Bushing Kit, 27.2mm (6 cyl. Only)	8-1128
<i>(Civic/CRX/Del Sol**)</i>		
84-87	Sway Bar Bushing Kit, 16mm Bar*	8-1103
88-91	Sway Bar Bushing Kit, 16mm Bar*	8-1105
88-91	Sway Bar Bushing Kit, 16mm Bar	8-1122
88-91	Sway Bar Bushing Kit, 18mm Bar	8-1106
88-91	Sway Bar Bushing Kit, 19mm Bar	8-1107
88-00	End Link Kit	8-401
92-95	Sway Bar Bushing Kit, 21mm Bar*	8-1101
92-95	Sway Bar Bushing Kit, 21mm Bar	8-1121
92-95	Sway Bar Bushing Kit, 22mm Bar	8-1109
92-95	Sway Bar Bushing Kit, 24mm Bar	8-1110
96-00	Sway Bar Bushing Kit, 22mm Bar	8-1123
01-05	Sway Bar Bushing Kit, 25.4mm Bar	8-1133

*Kit Includes End Links

**For 93-97 DelSol use 92-95 Civic listings

Honda (Continued)

SWAY BAR & END LINKS, FRONT (Continued)

<i>(Civic SI)</i>		
99-00	Sway Bar Bushing Kit, 26mm Bar	8-1125
<i>(Prelude)</i>		
92-96	End Link Kit	8-404
92-96	Sway Bar Bushing Kit, 25.4mm Bar	8-1130
97-01	Sway Bar Bushing Kit, 25.4mm Bar ("S")	8-1130
97-01	Sway Bar Bushing Kit, 24.2mm Bar ("SH")	8-1131

SWAY BAR BUSHINGS, REAR

<i>(Accord)</i>		
90-97	Sway Bar Bushing Kit, 14mm Bar	8-1116
94-97	Sway Bar Bushing Kit, 15mm Bar	8-1108
98-02	Sway Bar Bushing Kit, 16mm Bar (4 cyl. Only)	8-1126
98-02	Sway Bar Bushing Kit, 17mm Bar (6 cyl. Only)	8-1129
<i>(Civic/CRX/Del Sol**)</i>		
84-87	Sway Bar Bushing Kit, 14mm Bar	8-1104
88-91	Sway Bar Bushing Kit, 15mm Bar	8-1108
92-95	Sway Bar Bushing Kit, 13mm Bar	8-1111
99-00	Sway Bar Bushing Kit, 13mm Bar (Civic SI)	8-1124
01-05	Sway Bar Bushing Kit, 12mm Bar	8-1134
	**For 93-97 Del Sol use 92-95 Civic listings	

<i>(Prelude)</i>		
92-00	Sway Bar Bushing Kit, 23mm Bar	8-1132

TIE ROD BOOTS

84-00	Tie Rod Boot Kit (2) (Civic/CRX/Del Sol)	19-1711
90-97	Tie Rod Boot Kit (2) (Accord)	19-1711

TOTAL KITS*

<i>(Accord)</i>		
90-93	Total Kit (w/o Rear Upper C-Arm Bushings)	8-2006
90-93	Total Kit (with Rear Upper C-Arm Bushings)	8-2013
94-97	Total Kit (w/o Rear Upper C-Arm Bushings)	8-2007
94-97	Total Kit (with Rear Upper C-Arm Bushings)	8-2014
<i>(Civic, CRX, Del Sol**)</i>		
84-87	Total Kit	8-2001
88-91	Total Kit (w/o Rear Upper C-Arm Bushings)†	8-2002
88-91	Total Kit (with Rear Upper C-Arm Bushings)†	8-2009
92-95	Total Kit (w/o Rear Upper C-Arm Bushings)†	8-2003
92-95	Total Kit (with Rear Upper C-Arm Bushings)†	8-2010
96-00	Total Kit (With Frt. & Rr. Upper C-Arm Bushings)	8-2008
96-00	Total Kit (w/o Frt. & Rr. Upper C-Arm Bushings)	8-2017
01-05	Total Kit	8-2019
	**For 93-97 Del Sol use 92-95 Civic listings	

<i>(Civic SI)</i>		
99-00	Total Kit (w/o Frt. & Rr. Upper C-Arm Bushings)	8-2016
99-00	Total Kit (With Frt. & Rr. Upper C-Arm Bushings)	8-2015

<i>(Prelude)</i>		
92-96	Total Kit†	8-2018

*(Total Kits do not contain the Rear Trailing Arm Bushings)

†(Does not include Sway Bar Bushings)



Hyundai

MOTOR MOUNT INSERTS

(Tiburon)
03-05 Front Or Rear Motor Mount Insert Kit (V6 Only) 28-501

International

BODY MOUNTS

72-81 Body Mount Kit, 16 Pcs, (Scout II) 9-101

SPRING & SHACKLE BUSHINGS

(Scout 80)
61-65 Ft. Spring Eye and Shackle Bushing Kit 9-1002
61-65 Rr. Spring Eye and Shackle Bushing Kit 9-1002
61-68 Shackle Bushing Kit For 9-1002 9-802

(Scout 800)
66-68 Ft. Spring Eye & Shackle Kit 7/8" I.D. Spring 9-1002
66-68 Rr. Spring Eye and Shackle Kit 7/8" I.D. Spring 9-1002
68-71 Ft. Spring Eye and Shackle Kit 1 3/16" I.D. Spring 9-1003
68-71 Rr. Spring Eye and Shackle Kit 1 3/16" I.D. Spring 9-1003
61-68 Shackle Bushing Kit For 9-1002 9-802
68-71 Shackle Bushing Kit For 9-1003 9-803

(Scout II)
72-81 Ft. Spring Eye and Shackle Kit 9-1001
72-81 Rr. Spring Eye and Shackle Kit 9-1001
72-81 Shackle Bushing Only For 9-1001 9-801

TIE ROD BOOTS

61-81 Tie Rod Boot Kit (2) (Scout 80, 800 & II) 19-1712

Jaguar

CONTROL ARM BUSHINGS, FRONT

(All 59 to XJ6, 62 & L E Type, MK2 60 & L)
59 & L C-Arm Bushing Kit, Lower Inner 11-45028
59 & L C-Arm Bushing, Upper Inner 11-45029
(73 & L XJ12, XJS, XKE V12, 69 & L XJ6)
69 & L C-Arm Bushing Kit, Lower Inner 11-45028
69 & L C-Arm Bushing Kit, Upper Inner 11-45030
60-61 C-Arm Bushing Kit, Lower Inner (XK150) 11-45038
60-61 C-Arm Bushing Kit, Upper Inner (XK150) 11-45037

TORQUE ARM BUSHINGS, REAR

60 & L T-Arm Bushing Kit, Upper Front (Mark 2) 11-46025
60 & L T-Arm Bushing Kit, Upper Rear (Mark 2) 11-46025

DRIVE TRAIN

60 & L Panhard Rod Kit (Mark 2) 11-48020

SPRING EYE BUSHINGS

60 & L Rr. Spring Eye Bushing Kit, Rr. Eye (Mark 2) 11-47057

SPRING PADS

60 & L Rr. Spring Pad Kit (Mark 2) 11-47059

STEERING

60 & L Steering Drag Link Kit (Mark 2) 11-41033
(XJ12, XJS, XKE V12)
73 & L Steering Rack Mount Kit 11-41009

SWAY BAR BUSHINGS, FRONT

(All 59 to XJ6)
59 & L Sway Bar Bushing Kit, 17mm Bar 11-42057
59 & L Sway Bar Bushing Kit, 22mm Bar 11-42058
(XJ12, XJS, XKE V12)
73 & L Sway Bar Bushing Kit, 21mm Bar 11-42059
69 & L Sway Bar Bushing Kit, 20mm Bar (XJ6) 11-42061

SWAY BAR END LINKS, FRONT

(XJ6, MK2-60 & L, 73 & L XJ12, XJS, XKE V12, 69 & L XJ6)
59 & L End Link Kit 11-42060
(73 & L XJ12, XJS, XKE V12, 69 & L XJ6)
69 & L End Link Kit 11-42915
(XK 120/140/150 All, Mark 7/8/9 All)
49-61 End Link Kit 11-401-BL

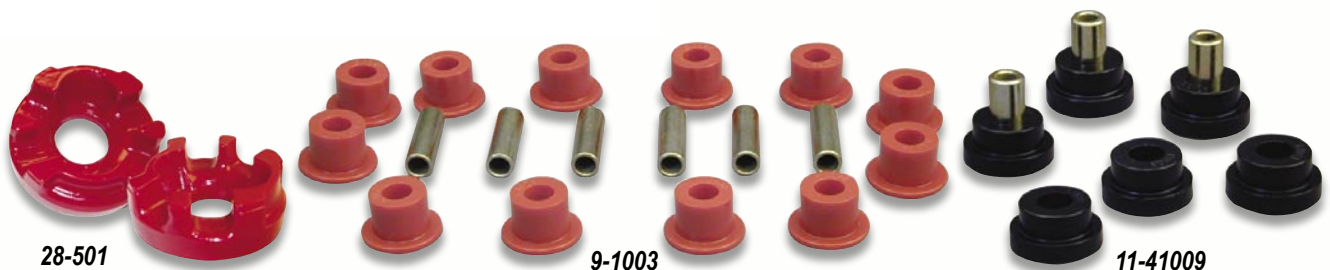

Jeep®

AXLE SNUBBERS

(CJ5, CJ7, CJ8, Wrangler-YJ)
76-96 Axle Snubber Kit (Replaces O.E.M. #5355483) 1-1301

BODY MOUNTS

(CJ5, CJ7, CJ8, Wrangler-YJ & TJ)
55-73 14 Bushing Kit 1-101
74-75 18 Bushing Kit 1-109
76-79 22 Bushing Kit 1-102
80-86 22 Bushing Kit 1-103
81-86 26 Bushing Kit (CJ8) 1-104
87-96 22 Bushing Kit 1-105
97-06 22 Bushing Kit 1-107
(Jeepster Commando)
67-73 26 Bushing Kit 1-108
(Grand Wagoneer, Wagoneer & Cherokee)
63-91 24 Bushing Kit (Grd. Wagoneer, Wagoneer) 1-106
74-83 24 Bushing Kit (Cherokee Full Size) 1-106

BODY MOUNTS, LIFT TYPE

(CJ5/CJ7)
76-79 Body Mount, 1" Lift (Incl. Hardware) 1-110
80-86 Body Mount, 1" Lift (Incl. Hardware) 1-111
(CJ8 Scrambler)
81-86 Body Mount, 1" Lift (Incl. Hardware) 1-112
(Wrangler, YJ/TJ)
87-96 Body Mount, 1" Lift (Incl. Hardware)(YJ) 1-113
97-06 Body Mount, 1" Lift (Incl. Hardware)(TJ) 1-114

CONTROL ARM BUSHINGS, FRONT & REAR

(Cherokee, Comanche, Grand Cherokee, Wrangler-TJ)
84-01 Ft. Control Arm Bushing Kit (Cherokee) 1-202
93-98 Ft. Control Arm Bushing Kit (Grand Cherokee) 1-203
93-98 Rr. Control Arm Bushing Kit (Grand Cherokee) 1-301
97-06 Ft. or Rr. C-Arm Bushing Kit (Upper & Lower) (TJ) 1-204
97-06 Ft. or Rr. C-Arm Bushing Kit (U.& L. w/Shells) (TJ) 1-205

Jeep® (Continued)

DRIVE TRAIN KITS

(CJ5, CJ7, CJ8)
76-86 Drive Train Kit (6 Cylinder, 258 CI) 1-1901
(Wrangler-YJ)
87-96 Drive Train Kit (6 Cylinder) 1-1902
(Above Kits Include: Motor Mounts, Trans. Mount, Trans. Torque Arm Bushings & Axle Snubbers)
(Wrangler-TJ)
97-06 Drive Train Kit (6 Cylinder) 1-1903
(Kit Includes: Trans. Mount & Motor Mounts Only)
(Various) Motor and Transmission Mount Combo Kits
(See Application Chart on Page 15)

MOTOR MOUNTS

(CJ5, CJ7, CJ8)
72-86 Motor Mount Kit (6 Cyl, 258 CI) 1-501
(Wagoneer & Cherokee)
74-85 Motor Mount Kit (6 Cyl, 258 CI) 1-501
(TJ, YJ, XJ, MJ)
87-06 Motor Mounts Kit, Pair (6 Cyl.) 1-502
(All w/ AMC V8 Engine)
67-92 Motor Mount Kit, Pair (V8) 1-503
(Grand Wagoneer)
84-91 Motor Mount Kit, Pair (6 cyl.) 1-501

SPRING & SHACKLE BUSHINGS, FRONT

(CJ5, CJ6, CJ7, CJ8 & Wrangler-YJ)
55-75 Spring Eye & Shackle Bushing Kit 1-1001
76-86 Spring Eye & Shackle Bushing Kit 1-1002
87-96 Spring Eye & Shackle Bushing Kit 1-1005
(Full Size Cherokee, Grd Wagoneer, Wagoneer & Pickup)
74-77 Spring Eye & Shackle Kit, w/ 1-1/4" OD Main Eye 1-1004
74-91 Spring Eye & Shackle Kit, w/ 2" OD Main Eye 1-1014

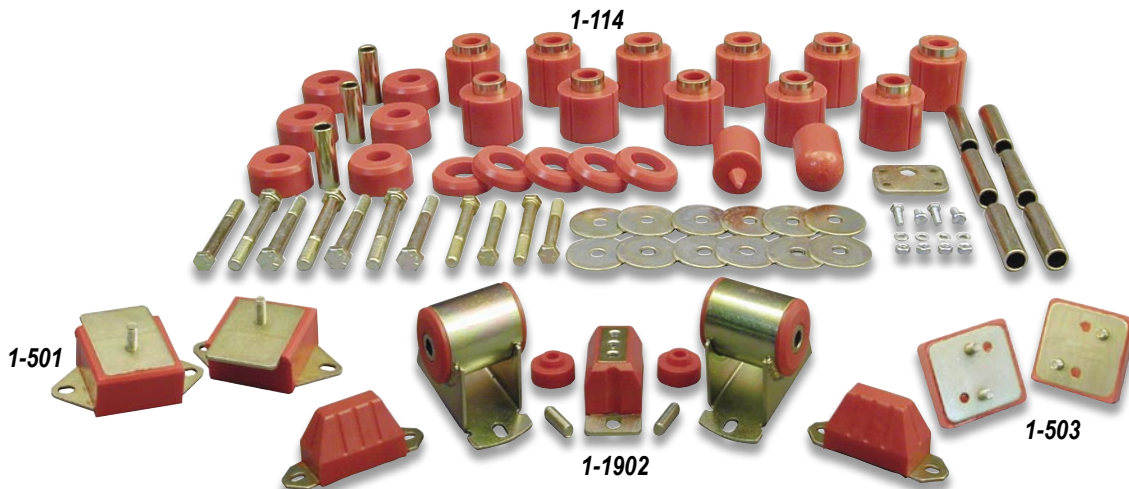

Jeep® (Continued)

SPRING & SHACKLE BUSHINGS, REAR

<i>(CJ5, CJ6, CJ7, CJ8 & Wrangler-YJ)</i>		
55-75	Spring Eye & Shackle Bushing Kit	1-1001
76-86	Spring Eye & Shackle Bushing Kit	1-1003
87-96	Spring Eye & Shackle Bushing Kit	1-1005
<i>(Cherokee, Comanche)</i>		
84-99	Spring Eye & Shackle Bushing Kit	1-1007

SHACKLE BUSHING KITS, FRONT & REAR

<i>(CJ5, CJ6, CJ7, CJ8, Wrangler-YJ)</i>		
55-75	Front or Rear Frame Shackle Bushing Kit	1-805
76-86	Front Frame Shackle Bushing Kit	1-801
76-86	Rear Frame Shackle Bushing Kit	1-802
87-96	Front or Rear Frame Shackle Bushing Kit	1-803
<i>(Cherokee, Comanche)</i>		
84-99	Rear Frame Shackle Bushing Kit	1-804

GREASEABLE SPRING & SHACKLE BUSHINGS, FRONT & REAR

<i>(CJ5, CJ7, CJ8, Wrangler-YJ)</i>		
55-75	Ft. & Rr. Main Spring Eye Bushing Kit	1-1015
55-75	Ft. or Rr. Shackle Bushing Kit (Upper & Lower)*	1-1015
76-86	Ft. & Rr. Main Spring Eye Bushing Kit	1-1016
76-86	Ft. Shackle Bushing Kit (Upper & Lower)*	1-814
76-86	Rr. Shackle Bushing Kit (Upper & Lower)*	1-815
87-96	Ft. & Rr. Main Spring Eye Bushing Kit	1-1017
87-96	Ft. or Rr. Shackle Bushing Kit (Upper & Lower)*	1-816
<i>(All Greaseable Bushing Kits include: Greaseable Bolts, Sleeves, Nuts & Washers)</i>		
<i>*Does not work with U-Type Shackles</i>		

COIL SPRING ISOLATORS, LIFT TYPE

<i>(Wrangler-TJ)</i>		
97-06	Ft. Coil Spring Isolator Kit, 1" Lift, Pr.	1-1702
97-06	Rr. Coil Spring Isolator Kit, 1-1/2" Lift, Pr.	1-1702
97-06	Front Coil Spring Isolator Kit, 1-1/2" Lift, Pr.	1-1703
97-06	Rear Coil Spring Isolator Kit, 2" Lift, Pr.	1-1703
97-06	Extended Front Bump Stop Kit, 1-1/2", Pr.	1-1302
97-06	1-1/2" Lift Isolator Kit, w/Extended Bump Stops	1-1705

Jeep® (Continued)

COIL SPRING ISOLATORS

<i>(Wrangler-TJ)</i>		
97-06	Front Spring Isolator Kit, Pair	1-1701

SWAY BAR BUSHINGS, FRONT

<i>(CJ5, CJ7, CJ8, Wrangler-YJ & TJ)</i>		
76-86	Sway Bar Bushing Kit, 15/16" Bar (CJ)	1-1101
76-86	Sway Bar Bushing Kit, 7/8" Bar (CJ)	1-1110
87-96	Sway Bar Bushing Kit, 15/16" Bar (YJ)	1-1102
87-96	Sway Bar Bushing Kit, 1-1/8" Bar (YJ)	1-1107
97-06	Sway Bar Bushing Kit, 30.5mm Bar (TJ)	1-1111
<i>(Cherokee, Comanche, Grand Cherokee 93-98, 2 & 4WD)</i>		
84-01	Sway Bar Bushing Kit, 24mm Bar	1-1103
84-01	Sway Bar Bushing Kit, 25mm Bar	1-1104
84-01	Sway Bar Bushing Kit, 28mm Bar	1-1105
84-01	Sway Bar Bushing Kit, 23mm Bar	1-1106
84-01	Sway Bar Bushing Kit, 1" Bar	1-1108
84-01	Sway Bar Bushing Kit, 7/8" Bar	1-1115
84-01	Sway Bar Bushing Kit, 15/16" Bar	1-1116
84-01	Sway Bar Bushing Kit, 1 1/8" Bar	1-1117
<i>(Grand Cherokee)</i>		
99-04	Sway Bar Bushing Kit, 1-1/4" Bar	1-1113

SWAY BAR BUSHINGS, REAR

<i>(Cherokee, Comanche, Grand Cherokee 2 & 4WD)</i>		
84-01	Sway Bar Bushing Kit, 5/8" Bar (Cherokee)	1-1118
93-98	Sway Bar Bushing Kit, 5/8" Bar (G. Cherokee)	1-1109
97-06	Sway Bar Bushing Kit, 13mm Bar (TJ)	1-1112
99-04	Sway Bar Bushing Kit, 9/16" Bar (G. Cherokee)	1-1114

TRACK ARM BUSHINGS, FRONT & REAR

<i>(Cherokee, Grand Cherokee, Comanche, Wrangler-YJ & TJ)</i>		
87-96	Ft. or Rr. Track Arm Bushing Kit ((Wrangler YJ)	1-1202
97-06	Front Track Arm Bushing Kit (Wrangler TJ)	1-1205
97-06	Rear Track Arm Bushing Kit (Wrangler TJ)	1-1206
84-01	Ft. Track Arm Bushing Kit (Cherokee)	1-1203
86-92	Ft. Track Arm Bushing Kit (Comanche)	1-1203
93-98	Ft. Track Arm Bushing Kit (Grand Cherokee)	1-1203
93-98	Rear Track Arm Bushing Kit (Grand Cherokee)	1-1204

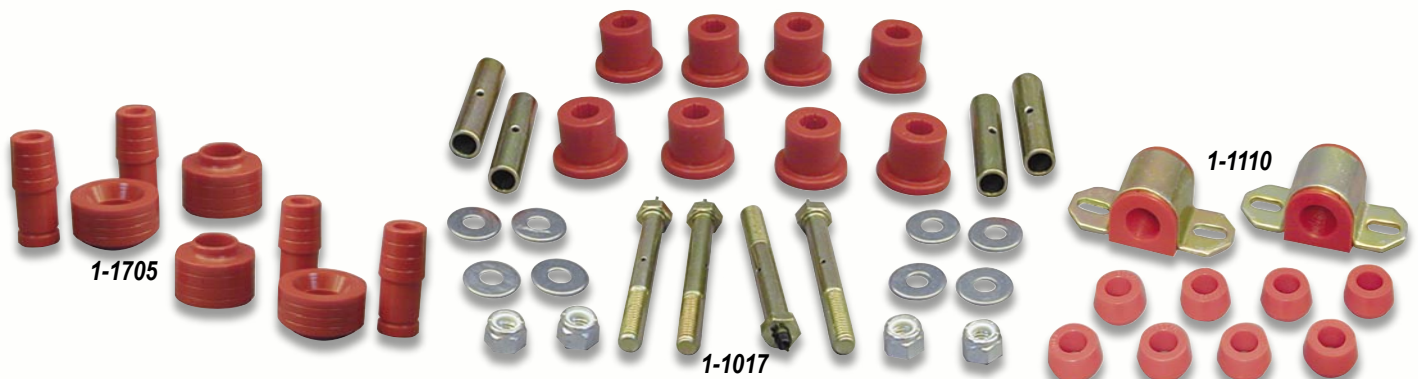

Jeep® (Continued)

TRANSMISSION MOUNTS

(CJ5, CJ7, CJ8, Wrangler-YJ & TJ)

73-96	Transmission Torque Arm Bushing Kit	1-1201
72-96	Trans. Mount Kit (Replaces O.E.M. #1370910)	7-1604
97-06	Transmission Mount Kit (Wrangler, TJ)	1-1601

(J Series Pickup)

63-87	Transmission Mount Kit (6cyl., 232 CI 4WD)	7-1604
75-87	Transmission Mount Kit (8cyl., 360 CI)	7-1604

(Cherokee, Wagoneer)

74-83	Transmission Mount Kit (6cyl., 258 CI)	7-1604
72-83	Transmission Mount Kit (8cyl., 360 CI)	7-1604

(Grand Wagoneer)

80-92	Transmission Mount Kit (6cyl.)	7-1604
84-91	Transmission Mount Kit (8cyl., 360 CI)	7-1604

TIE ROD BOOTS

55-01	Tie Rod Boot Kit (All Models)	19-1712
-------	-------------------------------	---------

TOTAL KITS

(CJ5 & CJ7)

55-73	Total Kit	1-2001
74-75	Total Kit, w/Trans. Mount	1-2013
76-79	Total Kit	1-2002
76-79	Total Kit, w/Trans. Mount	1-2007
80-86	Total Kit	1-2003
80-86	Total Kit w/Trans. Mount	1-2008

(CJ8 Scrambler)

81-86	Total Kit w/Trans. Mount	1-2014
-------	--------------------------	--------

(Wrangler YJ & TJ)

87-96	Total Kit (Wrangler YJ)	1-2005
87-96	Total Kit w/Trans. Mount (Wrangler YJ)	1-2009
97-06	Total Kit (Wrangler TJ)	1-2006

(Cherokee, Grand Cherokee)

84-01	Total Kit (Cherokee 2 & 4WD)	1-2004
93-98	Total Kit (Grand Cherokee)	1-2016

Lexus (Available in black only)

CONTROL ARM BUSHINGS, FRONT & REAR

(SC 300, 400)

92-96	Front C-Arm Bushing Kit	18-207-BL
92-96	Rear C-Arm Bushing Kit	18-304-BL

SWAY BAR BUSHINGS, FRONT & REAR

(SC 300, 400)

92-00	Front Sway Bar Bushing Kit, 30mm Bar	18-1121-BL
92-00	Rear Sway Bar Bushing Kit, 24mm Bar	18-1122-BL

(GS 300, 400, 430)

93-97	Front Sway Bar Bushing Kit, 30mm Bar	18-1128-BL
93-97	Rear Sway Bar Bushing Kit, 23mm Bar	18-1129-BL
98-05	Front Sway Bar Bushing Kit, 28.5mm Bar	18-1123-BL
98-05	Rear Sway Bar Bushing Kit, 14mm Bar	18-1124-BL

(IS 300)

01-05	Front Sway Bar Bushing Kit, 27.2mm Bar	18-1119-BL
01-05	Rear Sway Bar Bushing Kit, 14mm Bar	18-1124-BL

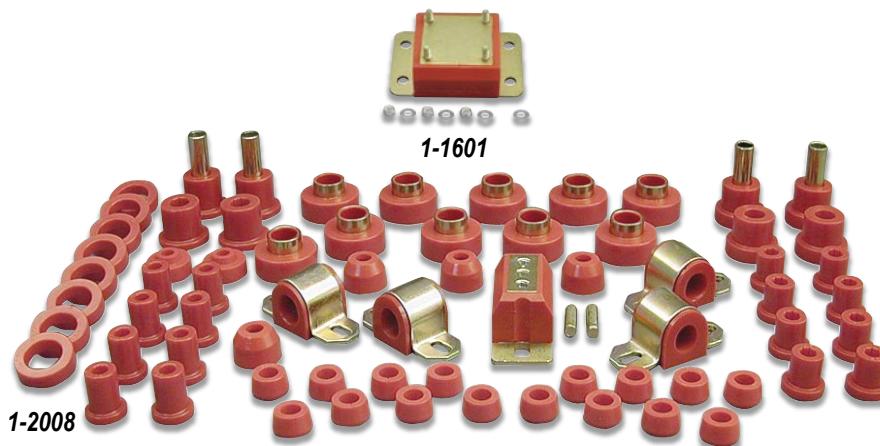

Lincoln/Mercury

COIL SPRING ISOLATORS

<i>(Capri)</i>			
79-86	Front Spring Isolators, Upper & Lower	6-1701	
83-86	Rear Spring Isolators, Upper & Lower	6-1703	

CONTROL ARM BUSHINGS, FRONT

<i>(Capri)</i>			
79-86	Front C-Arm Bushing Kit, w/o Shells*	6-205	
79-86	Front C-Arm Bushing Kit, w/Shells*	6-209	
79-86	Front C-Arm Bushing Kit, w/o Shells†	6-206	

<i>(Cougar)</i>			
67-73	Front C-Arm Bushing Kit, w/o Shells (w/1-7/16" Lower)	6-202	
67-73	Front C-Arm Bushing Kit, w/o Shells (w/1-9/16" Lower)	6-203	
74-97	Front C-Arm Bushing Kit, w/o Shells	6-210	
80-86	Front C-Arm Bushing Kit, w/o Shells*	6-205	
80-86	Front C-Arm Bushing Kit, w/o Shells†	6-206	
87-88	C-Arm Bushing Kit, w/o Shells	6-211	

*(Except HD Suspension) †(With HD Suspension)

(Grand Marquis w/Police, Tow & Taxi Pkg.)

92-94	Front C-Arm Bushing Kit w/o Shells	6-215	
95-97	Front C-Arm Bushing Kit w/o Shells	6-216	

CONTROL ARM BUSHINGS, REAR

<i>(Capri)</i>			
79-86	Rear C-Arm Bushing Kit, w/o Shells (w/Round Bushings)	6-301	
79-86	Rear C-Arm Bushing Kit, w/o Shells (Front Lower Oval Bushing)	6-302	

<i>(Cougar)</i>			
80-86	Rear C-Arm Bushing Kit, w/o Shells (w/Round Bushings)	6-301	
80-86	Rear C-Arm Bushing Kit, w/o Shells (Front Lower Oval Bushing)	6-302	

MOTOR MOUNTS

Various (See Application Chart on page 15)

Lincoln/Mercury (Continued)

STEERING

<i>(Capri)</i>			
79-9/84	Rack & Pinion Kit	6-702	
10/84-86	Rack & Pinion Kit	6-703	
10/84-86	Rack & Pinion Kit (Offset Style for Lowered Cars)	6-704	

<i>(Cougar)</i>			
85-88	Rack & Pinion Kit	6-703	
85-88	Rack & Pinion Kit (Offset Style for Lowered Cars)	6-704	

STRUT ROD BUSHINGS

<i>(Cougar)</i>			
67-73	Strut Rod Bushing Kit	6-1205	
74-79	Strut Rod Bushing Kit	6-1216	

STRUT TOWER BUSHINGS

<i>(Capri)</i>			
83-86	McPherson Strut Tower Bushing Kit	6-1213	

SWAY BAR BUSHINGS, FRONT

<i>(Capri)</i>			
79-86	Sway Bar Bushing Kit, 7/8" Bar	6-1120	
79-86	Sway Bar Bushing Kit, 15/16" Bar	6-1121	
79-86	Sway Bar Bushing Kit, 1" Bar	6-1122	
79-86	Sway Bar Bushing Kit, 1 1/16" Bar	6-1123	
79-86	Sway Bar Bushing Kit, 1 1/8" Bar	6-1124	
79-86	Sway Bar Bushing Kit, 1 1/8" Bar	6-1125	
79-86	Sway Bar Bushing Kit, 1 5/16" Bar	6-1126	

SWAY BAR END LINKS, FRONT

<i>(Capri)</i>			
79-86	End Link Kit	19-417	
<i>(Comet)</i>			
61-65	End Link Kit	19-401	
66-77	End Link Kit	19-405	
<i>(Cougar)</i>			
67-73	End Link Kit	19-408	
74-79	End Link Kit	19-409	
80-86	End Link Kit	19-417	
87-89	End Link Kit	19-412	
<i>(Monarch)</i>			
75-80	End Link Kit	19-401	
<i>(Marquis w/o Tow Package)</i>			
83-88	End Link Kit	19-412	
<i>(Versailles)</i>			
77-80	End Link Kit	19-405	



Lincoln/Mercury (Continued)

TIE ROD BOOTS

<i>(Capri)</i>		
79-86	Tie Rod Boot Kit (2)	19-1712
<i>(Cougar)</i>		
67-88	Tie Rod Boot Kit (2)	19-1712

TRANSMISSION MOUNTS

<i>(Capri)</i>		
79-86	Transmission Mount Kit, All	6-1604
79-86	Transmission X-Member Bushing Kit	6-1603
<i>(Comet)</i>		
66-69	Transmission Mount Kit, All	6-1605
<i>(Cougar)</i>		
67-73	Transmission Mount Kit, All	6-1605
80-88	Transmission Mount Kit, All	6-1604

TOTAL KITS

<i>(Capri)</i>		
79-86	Total Kit (w/o Trans. Mount)	6-2002
79-86	Total Kit (w/Trans. Mount)	6-2005

Mazda

BALL JOINT BOOTS

<i>(RX-7)</i>		
79-91	Ball Joint Boot Kit (2)	19-1713

CONTROL ARM BUSHINGS, FRONT & REAR

<i>(RX-7)</i>		
86-91	Front C-Arm Bushing Kit, w/o Shells	12-203
86-91	Rear C-Arm Bushing Kit, w/o Shells	12-202

SWAY BAR BUSHINGS, FRONT & REAR

<i>(Protege, 323)</i>		
90-95	Front Sway Bar Bushing Kit, 3/4" Bar	12-1101
90-95	Rear Sway Bar Bushing Kit, 15/16" Bar	12-1102
<i>(RX-7)</i>		
86-91	Front Sway Bar Bushing Kit, 24mm Bar	19-1123
86-91	Rear Sway Bar Bushing Kit, 14mm Bar	12-1103

(Mazda 3)

04-05	Front Sway Bar Bushing Kit	12-1104
04-05	Rear Sway Bar Bushing Kit, 19mm Bar	12-1105

(Mazda 6)

04-05	Front Sway Bar Bushing Kit	12-1106
04-05	Rear Sway Bar Bushing Kit, 18mm Bar	12-1107

SWAY BAR END LINKS

<i>(323, Protege)</i>		
79-82	End Link Bushing Kit	19-406
90-95	End Link Bushing Kit	4-401
<i>(RX-7)</i>		
79-85	End Link Bushing Kit	19-406
86-88	Front End Link Bushing Kit	12-401
86-88	Rear End Link Bushing Kit	12-402

TIE ROD BOOTS

<i>(626, MX6)</i>		
88-92	Tie Rod Boot Kit (2)	19-1713
<i>(RX-7)</i>		
79-85	Tie Rod Boot Kit (2)	19-1713
86-91	Tie Rod Boot Kit (2)	19-1711

TOTAL KITS

<i>(RX-7)</i>		
86-91	Total Kit	12-2001

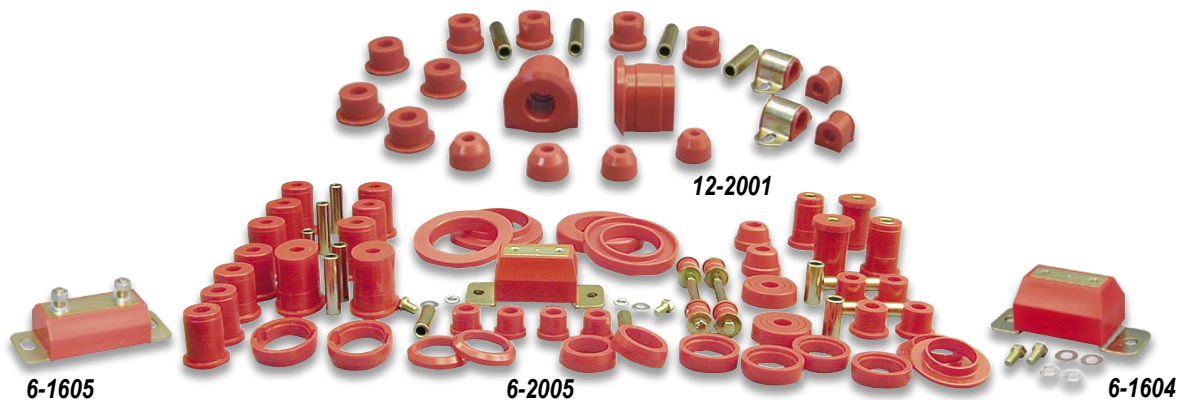

MG

CONTROL ARM BUSHINGS, FRONT

(60-63 MGA, 63-73 MGB "Rubber Nose", Midget)

60-73	C-Arm Bushing Kit, Lower, Inner	26-45046
62-74	C-Arm Bushing Kit, Lower, Inner (Midget)	26-45045

(MGB, Midget)

63-73	C-Arm Bushing Kit, Upper Outer	26-45045
62-74	C-Arm Bushing Kit, Upper Outer (Midget)	26-45054

DRIVE TRAIN

(MGB)

63-74 1/2	Ft. Cross Member Mount Kit	26-49017
74 1/2-80	Ft. Cross Member Mount Kit (U.S. Models)	26-49021
63-73	Gearbox Steady Rod Pad Kit	26-49018
63-73	Gearbox Steady Rod Eye Kit	26-49019
63-73	Gearbox X-Member Steady Kit	26-49020

SHOCK MOUNTS

(60-63 MGA, 63-73 MGB)

60-63	Rear Shock Link Kit	26-43038
63-73	Front Shock Link Kit (MGB)	26-43005

SPRING & SHACKLE BUSHINGS

(MGA, MGB)

60-63	Rear Spring Eye Kit, Front (MGA)	26-47076
60-73	Rear Spring Eye Kit, Rear	26-47075
60-73	Rear Spring Eye Kit, Shackle	26-47075
63-73	Rear Spring Eye Kit, Front (MGB)	26-47077
62-74	Rear Spring Eye Kit, Front (Midget)	26-47082
62-74	Rear Spring Eye or Shackle Kit, (Midget)	26-47083

SPRING PADS

60-73	Rear Spring Pad Kit	26-47078
-------	---------------------	----------

(MGA, MGB)

62-74	Rear Spring Pad Kit (Midget)	26-47084
-------	------------------------------	----------

SWAY BAR MOUNTS, FRONT

(63-73 MGB, 62-74 Midget)

62-74	Sway Bar Bushing Kit, 14mm Bar	26-42063
-------	--------------------------------	----------

SWAY BAR END LINKS

62-74	End Link Kit (Midget)	26-42064
-------	-----------------------	----------

Mitsubishi cars

CONTROL ARM BUSHINGS, FRONT

(Eclipse, Laser, Talon, AWD & FWD)

90-94	Control Arm Bushing Kit, Lower	13-202
95-99	Control Arm Bushing Kit, Upper & Lower	13-201

(Eclipse)

00-05	Control Arm Bushing Kit	13-203
-------	-------------------------	--------

CONTROL ARM BUSHINGS, REAR

(Eclipse, Talon, AWD & FWD)

95-99	Control Arm Bushing Kit, Upper & Lower	13-301
-------	--	--------

(Eclipse)

00-05	Control Arm Bushing Kit, Upper & Lower	13-302
-------	--	--------

MOTOR MOUNT INSERTS

(Eclipse, Laser, Talon FWD & AWD Turbo & Non-Turbo)

90-94	Trans. Mount Insert Kit (Right Upper)	13-501
90-94	Engine Mount Insert Kit (Front)	13-505
90-94	Engine Mount Insert Kit (Left Upper)	13-503
90-94	Engine Mount Insert Kit (Rear)	13-506
90-94	All 4 Mounts Kit	13-1902

(Eclipse, Talon FWD & AWD Turbo & Non-Turbo)

95-99	Trans Mount Insert Kit (Right Upper)	13-501
95-99	Engine Mount Insert Kit (Front)	13-502
95-99	Engine Mount Insert Kit (Left Upper)	13-503
95-99	Firewall Mount Insert Kit (Rear)	13-504
95-99	All 4 Mounts Kit	13-1901

(Eclipse, 4 cyl.)

00-05	Engine Mount Insert Kit (Right Upper)	13-503
00-05	Engine Mount Insert Kit (Front)	13-507
00-05	Engine Mount Insert Kit (Left Upper)	13-509
00-05	Engine Mount Insert Kit (Rear)	13-510
00-05	All 4 Mounts Kit	13-1904

(Eclipse, V6)

00-05	Engine Mount Insert Kit (Right Upper)	13-503
00-05	Engine Mount Insert Kit (Front)	13-507
00-05	Engine Mount Insert Kit (Left Upper)	13-509
00-05	Engine Mount Insert Kit (Rear)	13-508
00-05	All 4 Mounts Kit	13-1903

SHOCK BUSHINGS

(Eclipse, Talon, AWD & FWD)

95-99	Front Shock Bushing Kit	13-901
95-99	Rear Shock Bushing Kit	13-902

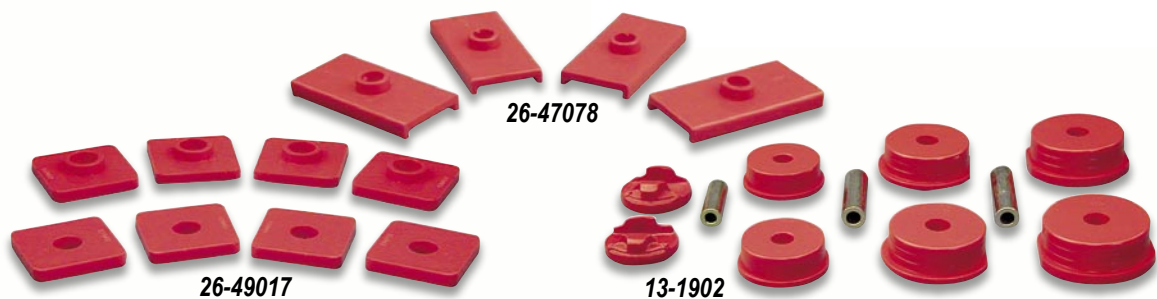

Mitsubishi cars (Continued)

SUB-FRAME MOUNTS

(Eclipse, Laser, Talon)

90-94	Sub-Frame Mount Kit (FWD)	13-101
90-94	Sub-Frame Mount Kit (AWD)	13-102

SWAY BAR BUSHINGS FRONT

(Eclipse, Laser, Talon)

90-94	Sway Bar Bushing Kit, 19mm Bar (FWD)	13-1104
90-94	Sway Bar Bushing Kit, 20mm Bar (AWD)	13-1105
95-99	Sway Bar Bush. Kit, 19mm Bar (FWD & AWD)	13-1101

(Eclipse)

00-05	Sway Bar Bushing Kit, 16mm Bar	13-1106
-------	--------------------------------	---------

SWAY BAR BUSHINGS REAR

(Eclipse, Laser, Talon)

90-94	Sway Bar Bushing Kit, 20mm Bar (AWD)	13-1107
95-99	Sway Bar Bushing Kit, 15mm Bar (FWD)	13-1102
95-99	Sway Bar Bushing Kit, 18mm Bar (AWD)	13-1103

(Eclipse)

00-05	Sway Bar Bushing Kit, 18mm Bar	19-1117
00-05	Sway Bar Bushing Kit, 19mm Bar	19-1118

TRACK ARM BUSHINGS

(Eclipse, Laser, Talon, FWD)

90-94	Rear Track Arm Bushing Kit	13-1201
-------	----------------------------	---------

TIE ROD BOOTS

(Eclipse, Laser, Talon, FWD & AWD)

90-94	Tie Rod Boot Kit (2)	19-1712
-------	----------------------	---------

TOTAL KITS

(Eclipse, Talon FWD & AWD)

95-99	Total Kit	13-2001
-------	-----------	---------

(Eclipse)

00-05	Total Kit	13-2002
-------	-----------	---------

Mitsubishi Truck

BODY MOUNTS

83-90	Body Mount Kit, 20 Pcs. (Pickup 2WD)	4-104
85-89	Body Mount Kit (Montero 2DR SWB)	13-103

CONTROL ARM BUSHINGS

83-90	C-Arm Bushing Kit, Lower (Pickup 2WD)	4-201
-------	---------------------------------------	-------

SPRING & SHACKLE BUSHINGS, REAR

83-90	Spring Eye and Shackle Bush. Kit (Pickup 2WD)	4-1006
-------	---	--------

STRUT ARM BUSHINGS

83-90	Strut Arm Bushing Kit (Pickup 2WD)	4-1201
-------	------------------------------------	--------

SWAY BAR BUSHINGS

83-90	Sway Bar Bushing Kit (Pickup 2WD)	4-1101
-------	-----------------------------------	--------

TIE ROD BOOTS

83-90	Tie Rod Boot Kit (2) (Pickup 2WD)	19-1712
-------	-----------------------------------	---------

Nissan/Datsun cars

CONTROL ARM BUSHINGS, FRONT

(240SX)

89-94	Control Arm Bushing Kit	14-207
95-98	Control Arm Bushing Kit	14-208

(240, 260, 280Z)

70-78	Control Arm Bushing Kit	14-203
-------	-------------------------	--------

(280ZX)

79-83	Control Arm Bushing Kit, Lower Only	14-204
-------	-------------------------------------	--------

(300ZX)

84-89	Control Arm Bushing Kit, Lower Only	14-206
-------	-------------------------------------	--------

(510)

68-73	Control Arm Bushing Kit, Lower Only	14-205
-------	-------------------------------------	--------

(610)

73-76	Control Arm Bushing Kit, Lower Only	14-204
-------	-------------------------------------	--------

CONTROL ARM BUSHINGS, REAR

(240SX)

89-94	Control Arm Bushing Kit	14-304
-------	-------------------------	--------

89-98	Control Arm Bushing Kit, Lower Only	14-305
-------	-------------------------------------	--------

95-98	Control Arm Bushing Kit	14-306
-------	-------------------------	--------

(240, 260, 280Z)

70-78	Control Arm Bushing Kit	14-301
-------	-------------------------	--------

(280ZX)

79-83	Control Arm Bushing Kit	14-302
-------	-------------------------	--------

(300ZX)

84-89	Control Arm Bushing Kit, Lower	14-303
-------	--------------------------------	--------

DRIVE TRAIN

(240, 260, 280Z)

70-78	Trans X Member Kit	14-1601
-------	--------------------	---------

70-78	Diff Carrier "Mustache Bar" Mount Kit	14-1602
-------	---------------------------------------	---------

MOTOR MOUNT INSERTS

(Sentra, 1.6/2.0 ltr., 200SX, NX2000, NX1600)

91-99	Engine Mount Insert Kit, Left or Rear	14-501
-------	---------------------------------------	--------

91-99	Engine Mount Insert Kit, Right	14-502
-------	--------------------------------	--------

91-99	Engine Torque Strut Insert Kit	14-503
-------	--------------------------------	--------

91-99	All 4 Mounts, Kit	14-1901
-------	-------------------	---------

STEERING

(240SX)

89-94	Steering Rack Bushing Kit	14-704
-------	---------------------------	--------

(240, 260, 280Z)

70-78	Steering Coupler Kit	14-701
-------	----------------------	--------

70-73	Rack & Pinion Bushing Kit (240Z)	14-702
-------	----------------------------------	--------

74-78	Rack & Pinion Bushing Kit (260Z, 280Z)	14-703
-------	--	--------

STRUT ROD BUSHINGS

(240SX)

89-98	Strut Rod Bushing Kit	14-1205
-------	-----------------------	---------

(240, 260, 280Z, 280ZX)

70-83	Strut Rod Bushing Kit	14-1202
-------	-----------------------	---------

(300ZX)

84-7/87	Strut Rod Bushing Kit	14-1203
---------	-----------------------	---------

8/87-89	Strut Rod Bushing Kit	14-1204
---------	-----------------------	---------

90-96	Strut Rod Bushing Kit	14-1205
-------	-----------------------	---------



Nissan/Datsun cars (Continued)

STRUT ROD BUMP STOPS

(240, 260, 280Z)

70-78 McPhearson Strut Bump Stops Kit, Ft. or Rr. 14-1301

SUBFRAME MOUNTS

(240SX)

89-94 Rear Subframe Bushing Insert Kit 14-102

(300ZX)

84-89 Rear Subframe Bushing Kit 14-101

SWAY BAR BUSHINGS, FRONT

(240SX)

89-94 Sway Bar Bushing Kit, 24mm Bar 14-1117

89-94 Sway Bar Bushing Kit, 25mm Bar 14-1118

95-98 Sway Bar Bushing Kit, 27mm Bar 14-1119

(240, 260, 280Z)

70-78 Sway Bar Bushing Kit, 16mm Bar 14-1104

70-78 Sway Bar Bushing Kit, 18mm Bar 14-1105

70-78 Sway Bar Bushing Kit, 20mm Bar 14-1107

(280ZX, 300ZX)

79-89 Sway Bar Bushing Kit, 22mm Bar 14-1109

79-89 Sway Bar Bushing Kit, 23mm Bar 14-1110

84-89 Sway Bar Bushing Kit, 24mm Bar 14-1111

(350Z)

03-04 Sway Bar Bushing Kit, 34mm Bar 14-1115

SWAY BAR BUSHINGS, REAR

(240SX)

89-94 Sway Bar Bushing Kit, 15mm Bar 14-1120

89-94 Sway Bar Bushing Kit, 17mm Bar 14-1121

95-98 Sway Bar Bushing Kit, 16mm Bar 14-1122

(260, 280Z, 280ZX)

74-83 Sway Bar Bushing Kit, 20mm Bar 14-1108

(300ZX)

84-89 Sway Bar Bushing Kit, 22mm Bar 14-1112

84-89 Sway Bar Bushing Kit, 23mm Bar 14-1113

84-89 Sway Bar Bushing Kit, 26mm Bar 14-1114

(350Z)

03-04 Sway Bar Bushing Kit, 21mm Bar 14-1116

SWAY BAR END LINKS, FRONT & REAR

(240, 260, 280Z)

70-78 Front or Rear End Link Kit 19-405

(280ZX)

79-83 Front or Rear End Link Kit 19-401

84-9/86 Front End Link Kit 19-401

84-89 Rear End Link Kit 19-408

TIE ROD BOOTS

(240SX)

89-98 Tie Rod Boot Kit 19-1711

(240, 260, 280Z, 280ZX)

70-83 Tie Rod Boot Kit (2) 19-1711

(510, 610, 810)

70-86 Tie Rod Boot Kit (2) 19-1711

(300ZX)

84-89 Tie Rod Boot Kit (2) 19-1714

Nissan/Datsun cars (Continued)

TOTAL KITS

(240SX)

89-94 Total Kit 14-2005

95-98 Total Kit 14-2006

(240Z)

70-73 Total Kit 14-2001

(260,280Z)

74-78 Total Kit 14-2002

(280ZX)

79-83 Total Kit 14-2003

(300ZX)

84-89 Total Kit 14-2004

Nissan/Datsun Trucks

CONTROL ARM BUSHINGS, FRONT

(720,Hardbody & Pathfinder, 2WD &4WD)

80-86 Control Arm Bushing Kit 14-201

86 1/2-97 Control Arm Bushing Kit 14-202

SPRING & SHACKLE BUSHINGS, REAR

(720, Hardbody 2WD)

80-86 Spring Eye and Shackle Bushing Kit 14-1001

86 1/2-97 Spring Eye & Shackle Bushing Kit 14-1003

(720, Hardbody 4WD)

80-86 Spring Eye and Shackle Bushing Kit 14-1001

86 1/2-97 Spring Eye and Shackle Bushing Kit 14-1002

STRUT ARM BUSHINGS, FRONT

(720, Hardbody & Pathfinder, 2WD & 4WD)

80-86 Strut Arm Bushing Kit 14-1201

SWAY BAR BUSHINGS, FRONT

(720, Hardbody & Pathfinder, 2WD)

80-86 Sway Bar Bushing Kit, 21mm Bar 14-1101

86 1/2-97 Sway Bar Bushing Kit, 23mm Bar 14-1102

(720, Hardbody & Pathfinder, 4WD)

80-86 Sway Bar Bushing Kit, 21mm Bar 14-1103

86 1/2-97 Sway Bar Bushing Kit, 20mm Bar 14-1106

(Titan 2WD & 4WD)

04-06 Sway Bar Bushing Kit, 34mm Bar 14-1123

TIE ROD BOOTS

(720, Hardbody & Pathfinder, 2WD & 4WD)

82-97 Tie Rod Boot Kit (2) 19-1712



14-2006

Oldsmobile

BALL JOINT BOOTS

<i>(Cutlass)</i>		
64-72	Ft. Ball Joint Boot Kit (4)	19-1715
<i>(Cutlass, 442, F85, Europa) RWD</i>		
73-87	Ball Joint Boot Kit (4)	19-1717
<i>(Omega)</i>		
73-74	Ball Joint Boot Kit (4)	19-1715
75-79	Ball Joint Boot Kit (4)	19-1717
<i>(Full Size, Except Toronado & FWD)</i>		
77-92	Ball Joint Boot Kit (4)	19-1717

BODY MOUNTS

<i>(Cutlass, 442, F-85, Europa) RWD</i>		
78-88	Body Mount Kit	7-132

COIL SPRING ISOLATORS, REAR

<i>(Full Size, except Toronado & FWD)</i>		
66-84	Coil Spring Isolator Kit, Rear Upper	7-1706
<i>(Cutlass, 442, F-85, Europa) RWD</i>		
67-88	Coil Spring Isolator Kit, Rear Upper	7-1706
<i>(Toronado)</i>		
71-78	Coil Spring Isolator Kit, Rear Upper	7-1706

CONTROL ARM BUSHINGS, FRONT

<i>(Full Size, except Toronado & FWD)</i>		
71-73	Control Arm Bushing Kit, w/Shells	7-212
74-79	Control Arm Bushing Kit, w/Shells	7-214
80-92	Control Arm Bushing Kit, w/Shells	7-216
<i>(Cutlass, Calais, 442, F-85) RWD</i>		
65	Control Arm Bushing Kit, w/Shells	7-221
66-72	Control Arm Bushing Kit, w/Shells (w/ oval lower)	7-222
66-72	Control Arm Bushing Kit, w/Shells (w/ round lower)	7-217
73	Control Arm Bushing Kit, w/Shells	7-212
74-77	Control Arm Bushing Kit, w/Shells	7-214
78-87	Control Arm Bushing Kit, w/Shells	7-223
<i>(Omega)</i>		
73-74	Control Arm Bushing Kit, w/Shells	7-217
75-79	Control Arm Bushing Kit, w/Shells	7-214
<i>(Achieva, Calais, Firenza) FWD</i>		
82-91	Control Arm Bushing Kit, w/Shells	7-224

CONTROL ARM BUSHINGS, REAR

<i>(Cutlass, Calais, 442, F-85) RWD</i>		
66-87	Control Arm Bushing Kit, w/Shells	7-225

MOTOR MOUNTS

Various (See Application Chart on page 15)

RADIATOR ISOLATORS

<i>(Cutlass, Calais, 442, F85)</i>		
68-72	Radiator Isolators, Small Block (4pcs)	7-1711
68-72	Radiator Isolators, Big Block (4pcs)	7-1712

Oldsmobile (Continued)

SWAY BAR BUSHINGS, REAR

<i>(Achieva, Calais) FWD</i>		
85-94	Sway Bar Bushing Kit, 15mm Bar	7-1156
85-94	Sway Bar Bushing Kit, 17mm Bar	7-1157
85-94	Sway Bar Bushing Kit, 19mm Bar	7-1158

SWAY BAR END LINKS

<i>(Full Size, except Toronado & FWD)</i>		
71-92	Front End Link Kit	19-408
<i>(Achieva, Calais) FWD</i>		
85-94	Front End Link Kit	19-408
<i>(Cutlass, Calais, Omega, 442, F-85) RWD</i>		
64-77	Front End Link Kit	19-408
78-81	Front End Link Kit	19-412
73-79	Front End Link Kit (Omega)	19-408

TIE ROD BOOTS

All	Tie Rod Boot Kit (2)	19-1712
-----	----------------------	---------

TRANSMISSION MOUNTS

Various (See Application Chart on Page 15)

TOTAL KITS

<i>(Cutlass, 442)</i>		
66-72	Total Kit	7-2001
74-77	Total Kit	7-2004
78-87	Total Kit	7-2007



Pontiac Firebird

BALL JOINT BOOTS

67-69	Ft. Ball Joint Boot Kit (4) (Includes Trans Am)	19-1715
70-81	Ball Joint Boot Kit (4)	19-1717

BODY MOUNTS

67-69	Body Mount Kit (Convertible Only) w/Hardware	7-120
67-75	Body Mount Kit (Hardtop) w/o Hardware	7-119
67-75	Body Mount Kit (Hardtop Only) w/Hardware	7-139
67-75	Body Mount Hardware Kit Only, (For 7-119)	7-140
76-81	Body Mount Kit w/Hardware	7-127

CONTROL ARM BUSHINGS, FRONT

67-69	Control Arm Bushing Kit w/Shells	7-217
70-72	Control Arm Bushing Kit w/Shells	7-218
73	Control Arm Bushing Kit w/Shells (w/ 1.625" OD lower)	7-212
74-79	Control Arm Bushing Kit w/Shells	7-214
80-81	Control Arm Bushing Kit w/Shells	7-219
82-92	Control Arm Bushing Kit w/Shells	7-220
93-02	Control Arm Bushing Kit w/Shells	7-227

CONTROL ARM BUSHINGS, REAR

82-02	Control Arm Bushing Kit w/Shells	7-226
-------	----------------------------------	-------

DRIVE TRAIN

84-92	Diff To Trans Torque Arm Kit	7-1611
84-02	Diff To Trans Torque Arm Kit (84-92 Varies)	7-1609
82-02	Panhard Rod Kit	7-1201
82-92	Secondary Trans. Crossmember Kit	7-1605

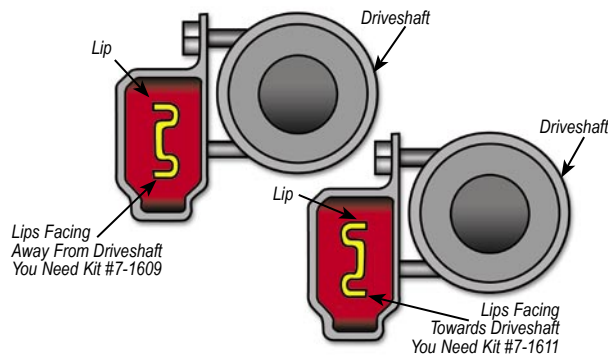

MOTOR MOUNTS

Various (See Application Chart on Page 15)

SPRING & SHACKLE BUSHINGS, REAR

67-69	Spring Eye & Shackle Kit (Mono Leaf)	7-1010
67-69	Spring Eye & Shackle Kit (Multi Leaf)	7-1011
70-81	Spring Eye & Shackle Kit (Multi Leaf)	7-1012
67-69	Spring Eye & HD Shackle Kit (Mono Leaf)	7-1052
67-69	HD Shackle Kit (Mono Leaf)	7-1053
67-81	Spring Eye & HD Shackle Kit (Multi Leaf)	7-1050
67-81	HD Shackle Kit (Multi Leaf)	7-1051

SPRING PADS, REAR

68-69	Spring Pad Kit, Upper Or Lower (Multi Leaf)	7-1701
70-81	Spring Pad Kit, Lower (Multi Leaf)	7-1702

Pontiac Firebird (Continued)

SPRING PADS, REAR (Continued)

70-81	Spring Pad Kit, Upper (Multi Leaf)	7-1703
68-69	Spring Pad Kit, Upper & Lower (Multi Leaf)	7-1708
70-81	Spring Pad Kit, Upper & Lower (Multi Leaf)	7-1709
67-69	Spring Pad Kit, Upper (Mono Leaf)	7-1704
67-69	Spring Pad Kit, Lower (Mono Leaf)	7-1705
67-69	Spring Pad Kit, Upper & Lower (Mono Leaf)	7-1707

SWAY BAR BUSHINGS, FRONT

82-92	Sway Bar Bushing Kit, 30mm Bar	7-1133
82-92	Sway Bar Bushing Kit, 32mm Bar	7-1134
82-92	Sway Bar Bushing Kit, 34mm Bar	7-1135
93-02	Sway Bar Bushing Kit, 30mm Bar	7-1136
93-02	Sway Bar Bushing Kit, 32mm Bar	7-1137

SWAY BAR BUSHINGS, REAR

82-02	Sway Bar Bushing Kit, 19mm Bar	7-1129
82-02	Sway Bar Bushing Kit, 21mm Bar	7-1130
82-02	Sway Bar Bushing Kit, 23mm Bar	7-1131
82-02	Sway Bar Bushing Kit, 24mm Bar (1 Bolt Clamp)	7-1132
67-81	Sway Bar Bushing Kit, 5/8" Bar	7-1122
67-81	Sway Bar Bushing Kit, 11/16" Bar	7-1123
67-81	Sway Bar Bushing Kit, 3/4" Bar	7-1124
67-81	Sway Bar Bushing Kit, 13/16" Bar	7-1125
67-81	Sway Bar Bushing Kit, 7/8" Bar	7-1126
67-81	Sway Bar Bushing Kit, 15/16" Bar	7-1127
67-81	Sway Bar Bushing Kit, 1" Bar (2 Bolt Clamp)	7-1128
67-81	Sway Bar Bushing Kit, 9/16" Bar	7-1116
67-81	Sway Bar Bushing Kit, 5/8" Bar	7-1117
67-81	Sway Bar Bushing Kit, 11/16" Bar	7-1118
67-81	Sway Bar Bushing Kit, 3/4" Bar	7-1119
67-81	Sway Bar Bushing Kit, 13/16" Bar	7-1120
67-81	Sway Bar Bushing Kit, 7/8" Bar	7-1121

SWAY BAR END LINKS, FRONT

67-92	End Link Kit	19-406
93-02	End Link Kit	19-409

TIE ROD BOOTS

67-02	Tie Rod Boot Kit (2)	19-1712
-------	----------------------	---------

TRANSMISSION MOUNTS

Various (See Application Chart on Page 15)

TOTAL KITS

(Firebird)		
67-69	Total Kit	7-2002
70-72	Total Kit	7-2028
73	Total Kit	7-2029
74-75	Total Kit	7-2005
76-79	Total Kit	7-2006
80-81	Total Kit	7-2031
82-92	Total Kit	7-2008
93-02	Total Kit	7-2009

Pontiac Full Size

BALL JOINT BOOTS

64-81	Ft. Ball Joint Boot Kit (4) (Bonneville-RWD, Grand Prix-to '81, Catalina)	19-1715
73-86	Ball Joint Boot Kit (4)	19-1717

BODY MOUNTS

(Bonneville, Catalina, Grand Prix thru 81, Grandville, Safari Wagon) RWD		
80-87	Body Mount Kit	7-132

COIL SPRING ISOLATORS, REAR

(Bonneville, Catalina, Grand Prix thru 81, Grandville, Safari Wagon) RWD		
67-86	Coil Spring Isolator Kit, Rear Upper	7-1706

CONTROL ARM BUSHINGS, FRONT

(Bonneville-RWD, Grand Prix-to 81, Catalina)		
71-73	Control Arm Bushing Kit, w/Shells	7-212
74-79	Control Arm Bushing Kit, w/Shells	7-214
80-81	Control Arm Bushing Kit, w/Shells	7-216
82-87	Control Arm Bushing Kit, w/Shells	7-223

CONTROL ARM BUSHINGS, REAR

(Bonneville-RWD, Catalina)		
82-87	Control Arm Bushing Kit, w/Shells	7-225

MOTOR MOUNTS

Various (See Application Chart on Page 15)

SWAY BAR END LINKS, FRONT

(Bonneville-RWD, Grand Prix-to 81, Catalina)		
71-88	End Link Kit	19-408

TIE ROD BOOTS

All	Tie Rod Boot Kit (2)	19-1712
-----	----------------------	---------

TRANSMISSION MOUNTS

Various (See Application Chart on Page 15)



Pontiac Mid Size & Compact

BALL JOINT BOOTS

(GTO, LeMans, Tempest, Grand Am)		
64-72	Ball Joint Boot Kit (4)	19-1715
73-81	Ball Joint Boot Kit (4) (Phoenix, Ventura)	19-1717
71-74	Ball Joint Boot Kit (4)	19-1715
75-79	Ball Joint Boot Kit (4)	19-1717

BODY MOUNTS

(Grand Prix)		
82-88	Body Mount Kit	7-132

COIL SPRING ISOLATORS, REAR

(GTO, Lemans, Tempest, Grand Am to 81, Grand Prix 82-88)		
67-88	Coil Spring Isolator Kit, Rear Upper	7-1706

CONTROL ARM BUSHINGS, FRONT

(GTO, Le Mans, Tempest, Grand Am To 81, Grand Prix 82-88)		
64-66	Control Arm Bushing Kit, w/Shells	7-221
67-72	Control Arm Bushing Kit, w/Shells (w/ oval lower)	7-222
73	Control Arm Bushing Kit, w/Shells	7-212
74-77	Control Arm Bushing Kit, w/Shells	7-214
78-81	Control Arm Bushing Kit, w/Shells	7-223
82-88	Control Arm Bushing Kit, w/Shells (Grand Prix)	7-223
04-06	Control Arm Bushing Kit, w/o Shells (GTO)	7-235
(Phoenix, Ventura)		
71-74	Control Arm Bushing Kit, w/Shells	7-217
75-79	Control Arm Bushing Kit, w/Shells	7-214
(Grand Am & Sunbird)		
87-94	Control Arm Bushing Kit, w/Shells	7-224
(Sunfire)		
95-04	Control Arm Bushing Kit, w/o Shells	7-234

CONTROL ARM BUSHINGS, REAR

(GTO, Le Mans, Tempest, Grand Am To 81, Grand Prix 82-88)		
64	Control Arm Bushing Kit (Uppers Must Reuse Existing Outer Shells)	7-314
65-81	Control Arm Bushing Kit, w/Shells	7-225
82-88	Control Arm Bushing Kit, w/Shells (Grand Prix)	7-225
04-06	Control Arm Bushing Kit (GTO)	7-317

MOTOR MOUNTS

Various (See Application Chart on Page 15)		
(Sunfire 5 spd. & Auto Non Ecotec)		
95-04	Upper Engine Mount Insert	7-513
95-04	Lower Engine Torque Strut	7-511
95-04	Transmission Mount Insert Kit (Ft. Mt. Manual Only)	7-514
95-04	Transmission Mount Insert Kit (Rr. Mt. Manual Only)	7-515

RADIATOR ISOLATORS

(GTO, LeMans, Tempest)		
68-72	Radiator Isolators, Small Block (4pcs)	7-1711
68-72	Radiator Isolators, Big Block (4pcs)	7-1712

STRUT ROD BUSHINGS

(GTO)		
04-06	Front Strut Rod Bushing Kit	7-1212

Pontiac Mid Size & Compact (Continued)

SWAY BAR BUSHINGS, FRONT

(Grand Am, Sunbird, Sunfire)

87-98	Sway Bar Bushing Kit, 24mm Bar	7-1159
87-98	Sway Bar Bushing Kit, 26mm Bar	7-1160
87-98	Sway Bar Bushing Kit, 28mm Bar	7-1161
87-98	Sway Bar Bushing Kit, 30mm Bar	7-1162

(GTO)

04-06	Sway Bar Bushing Kit, 28mm Bar*	7-1182
-------	---------------------------------	--------

SWAY BAR BUSHINGS, REAR

(Grand Am, Sunbird)

87-94	Sway Bar Bushing Kit, 15mm Bar	7-1156
87-94	Sway Bar Bushing Kit, 17mm Bar	7-1157
87-94	Sway Bar Bushing Kit, 19mm Bar	7-1158

(GTO)

04-06	Sway Bar Bushing Kit 16mm Bar*	7-1183
-------	--------------------------------	--------

*Includes End Link Bushings

SWAY BAR END LINKS, FRONT

(GTO, Le Mans, Tempest, Grand Am To 81, Grand Prix 82-88)

64-72	End Link Kit	19-412
73-77	End Link Kit	19-408
78-81	End Link Kit	19-412
82-88	End Link Kit (Grand Prix)	19-408

(Phoenix, Ventura)

71-74	Sway Bar End Link Kit	19-409
75-79	Sway Bar End Link Kit	19-408

TIE ROD BOOTS

All	Tie Rod Boot Kit (2)	19-1712
-----	----------------------	---------

TRANSMISSION MOUNTS

Various (See Application Chart on Page 15)

TOTAL KITS

(GTO, Le Mans)

1966	Total Kit	7-2037
67-72	Total Kit	7-2038
74-77	Total Kit	7-2004
78-81	Total Kit (Grand Am)	7-2007
82-88	Total Kit (Grand Prix)	7-2007
04-06	Total Kit (GTO)	7-2041

Pontiac Fiero

CONTROL ARM BUSHINGS

84-88	Ft. C-Arm Bushing Kit, w/o Shells	7-207
84-87	Rr. C-Arm Bushing Kit, w/o Shells	7-304

MOTOR & DRIVE TRAIN

84-87	Engine Cradle Mount Kit	7-502
84-88	Engine Torque Strut Bushing Kit, 4 Cyl.	7-501
85-86	Engine Torque Strut Bushing Kit, 6 Cyl	7-501

TRAILING ARM BUSHINGS, REAR

88	Rear Link Trailing Arm Bushing Kit	7-305
----	------------------------------------	-------

SWAY BAR BUSHINGS, FRONT

84-87	Sway Bar Bushing Kit, 23mm Bar	19-1122
-------	--------------------------------	---------

SWAY BAR END LINKS, FRONT

84-87	End Link Kit	19-408
-------	--------------	--------

TOTAL KITS

84-87	Total Kit	7-2034
-------	-----------	--------



7-2034

Porsche

TRANSMISSION

(356 All)

50-65	Rr. Linkage Coupler Bushing Kit	15-1601
(911, 912, & 930)		
65-88	Rr. Linkage Coupler Bushing Kit	15-1601



7-511

7-514

7-515

7-502

15-1601

Rover

DRIVE TRAIN

52-78	Ft. Panhard Rod Bushing Kit (110 Model)	25-48035
72-85	Ft. Panhard Rod Bushing Kit (Range Rover)	25-48034

RADIUS ROD BUSHINGS

52 & L	Radius Rod to Chassis Kit (110 Model)	25-48024
84-86	Radius Rod to Chassis Kit (Range Rover)	25-48101
86 & L	Radius Rod to Chassis Kit (Range Rover)	25-48024
52-78	Radius Rod to Differential Kit (110 Model)	25-48032
72-86	Radius Rod to Differential Kit (Range Rover)	25-48032
84 & L	Radius Rod to Differential Kit (Range Rover)	25-48033

SHOCK BUSHINGS

<i>(110 Model)</i>		
52-78	Ft. Shock Mount Bushing Kit, Lower	25-43022
52-78	Rr. Shock Mount Bushing Kit, Lower	25-43022

(Land Rover, Series 1, 2, 2A, & 3)

78 & E	Ft. Shock Mount Bushing Kit, Upper	25-43022
78 & E	Ft. Shock Mount Bushing Kit, Lower	25-43022
78 & E	Rr. Shock Mount Bushing Kit, Upper	25-43022
78 & E	Rr. Shock Mount Bushing Kit, Lower	25-43022
78 & E	Rr. Shock Mount Bushing Kit, Lower (Series 3) (109 Pin Type)	25-43007

(Range Rover)

84 & L	Rr. Shock Bushing Kit Rr, Upper, (DeCarbon)	25-43022
84 & L	Rr. Shock Bushing Kit Rr, Lower, (DeCarbon)	25-43001

SPRING & SHACKLE BUSHINGS, FRONT & REAR

(Land Rover Series 1 & 2)

78 & E	Ft. Spring, Front Spring Eye & Shackle Kit	25-47072
78 & E	Rr. Spring, Front Spring Eye & Shackle Kit	25-47072

(Land Rover Series 2A)

78 & E	Ft. Spring, Front Spring Eye Kit	25-47021
78 & E	Ft. Spring, Rear Spring Eye Kit	25-47021
78 & E	Rr. Spring, Spring Eye & Shackle Kit	25-47021

(Land Rover Series 3)

78 & E	Ft. Spring, Front Spring Eye Kit	25-47021
78 & E	Ft. Spring, Rear Spring Eye Kit	25-47021
78 & E	Rr. Spring, Spring Eye & Shackle Kit	25-47021

STEERING DAMPER

84 & L	Steering Damper Bushing Kit (Range Rover)	25-43010
--------	---	----------

TRACK ROD

(Range Rover)

84 & L	Track Rod to Chassis Bushing Kit, 16mm	25-48038
84 & L	Track Rod to Chassis Bushing Kit, 20mm	25-48040
84 & L	Track Rod to Differential Bushing Kit	25-48036

TRAILING ARM

(110 Model)

52-78	Trailing Arm Eye Kit	25-48036
52-78	Trailing Arm Mount, Kit, 16mm	25-48038
52-78	Trailing Arm Mount, Kit, 20mm	25-48040

(110 Model, Range Rover)

84 & L	Trailing Arm Kit, Upper	25-48037
--------	-------------------------	----------

Saturn

MOTOR MOUNTS

<i>(S-Car)</i>		
92-00	Engine Torque Strut Insert Kit	7-510

Scion

SWAY BAR BUSHINGS, FRONT

<i>(Scion tC)</i>		
05-06	Sway Bar Bushing Kit, 21mm Bar	18-1132

SWAY BAR BUSHINGS, REAR

<i>(Scion tC)</i>		
05-06	Sway Bar Bushing Kit, 18mm Bar	18-1133

Subaru

CONTROL ARM BUSHINGS, FRONT

<i>(WRX, Impreza)</i>		
98-05	Control Arm Bushing Kit	16-201

TRAILING ARM BUSHINGS, REAR

<i>(WRX, Impreza)</i>		
98-05	Trailing Arm Bushing Kit	16-301

SHIFTER BUSHINGS

<i>(WRX, Impreza, Outback, Legacy, Forester)</i>		
98-05	Shifter Bushing Kit	16-1601

SWAY BAR BUSHINGS, FRONT

<i>(WRX STI, Impreza)</i>		
98-05	Sway Bar Bushing Kit, 20mm Bar	16-1101

SWAY BAR BUSHINGS, REAR

<i>(WRX, Impreza)</i>		
98-05	Sway Bar Bushing Kit, 17mm Bar	16-1102

(WRX STI)

04	Sway Bar Bushing Kit, 19mm Bar	16-1103
----	--------------------------------	---------

(WRX STI)

05	Sway Bar Bushing Kit, 20mm Bar	16-1104
----	--------------------------------	---------

TOTAL KIT

<i>(WRX, Impreza)</i>		
98-05	Total Kit	16-2001

Suzuki

SPRING & SHACKLE BUSHINGS, FRONT & REAR

(Samurai)

85-88 1/2	Front Spring Eye & Shackle Bushing Kit (O.E.M. Shackles)	17-1001
85-88 1/2	Rear Spring Eye & Shackle Bushing Kit (O.E.M. Shackles)	17-1001
85-88 1/2	Front Spring Eye & Shackle Bushing Kit (Aftermarket Shackles)	17-1002
85-88 1/2	Rear Spring Eye & Shackle Bushing Kit (Aftermarket Shackles)	17-1002

SWAY BAR BUSHINGS, FRONT

(Samurai)

85-88 1/2	Sway Bar Bushing Kit, 22mm Bar	17-1101
-----------	--------------------------------	---------

TIE ROD BOOTS

85-88 1/2	Tie Rod Boot Kit (2)	19-1711
-----------	----------------------	---------



Toyota car

CONTROL ARM BUSHINGS, FRONT

<i>(Celica)</i>		
71-85	Control Arm Bushing Kit	18-210
00-05	Control Arm Bushing Kit	18-203
<i>(Celica Supra/Supra)</i>		
79-86-1/2	Control Arm Bushing Kit	18-210
<i>(Corolla GTS, SR-5) RWD</i>		
71-87	Control Arm Bushing Kit	18-210
<i>(MR2)</i>		
85-89	Control Arm Bushing Kit	18-208
91-95	Control Arm Bushing Kit, w/Strut Rod Bushings	18-209

CONTROL ARM BUSHINGS, REAR

<i>(Celica)</i>		
00-05	Control Arm Bushing Kit	18-302
<i>(Corolla GTS, SR-5) RWD</i>		
85-87	Control Arm Bushing Kit	18-305
<i>(MR2)</i>		
85-89	Control Arm Bushing Kit	18-208
91-95	Control Arm Bushing Kit, w/Strut Rod Bushings	18-303

STEERING RACK BUSHINGS

<i>(Corolla GTS, SR-5) RWD</i>		
85-87	Steering Rack Bushing Kit (Manual Only)	18-702
85-87	Steering Rack Bushing Kit (Power Only)	18-703
<i>(MR2)</i>		
85-89	Steering Rack Bushing Kit	18-702

STRUT ROD BUSHINGS, FRONT

<i>(Celica)</i>		
77-85	Strut Rod Bushing Kit	18-1203
<i>(Celica Supra/Supra)</i>		
79-86 1/2	Strut Rod Bushing Kit	18-1203
<i>(Corolla GTS, SR-5) RWD</i>		
75-87	Strut Rod Bushing Kit	18-1203
<i>(MR2)</i>		
85-89	Strut Rod Bushing Kit	18-1203

STRUT ROD BUSHINGS, REAR

<i>(MR2)</i>		
85-89	Strut Rod Bushing Kit	18-1204

SWAY BAR BUSHINGS, FRONT

<i>(Celica)</i>		
00-05	Sway Bar Bushing Kit, 22mm Bar	19-1121
<i>(Corolla GTS, SR-5) RWD</i>		
85-87	Sway Bar Bushing Kit, 21mm Bar (SR-5 Only)	19-1120
85-87	Sway Bar Bushing Kit, 22mm Bar (GTS Only)	19-1121
<i>(MR2)</i>		
85-89	Sway Bar Bushing Kit, 18mm Bar	18-1120
91-95	Sway Bar Bushing Kit, 19mm Bar	18-1126

SWAY BAR BUSHINGS, REAR

<i>(Celica)</i>		
00-05	Sway Bar Bushing Kit, 17mm Bar	19-1116
<i>(Corolla GTS, SR-5) RWD</i>		
85-87	Sway Bar Bushing Kit, 14mm Bar	18-1130
85-87	Sway Bar Bushing Kit, 16mm Bar	18-1131

Toyota car (Continued)

SWAY BAR BUSHINGS, REAR (Continued)

<i>(MR2)</i>		
85-89	Sway Bar Bushing Kit, 18mm Bar	18-1120
91-95	Sway Bar Bushing Kit, 19mm Bar	18-1127

SWAY BAR END LINKS

78-85	End Link Kit (Celica, GTS)	19-403
70-86	End Link Kit (Corolla)	19-403
79-86	End Link Kit (Supra)	19-403

(Corolla GTS, SR-5) RWD

85-87	Front End Link Kit	19-421
85-87	Rear End Link Kit	18-401

TIE ROD BOOTS

78-85	Tie Rod Boot Kit (2) (Celica, GTS)	19-1712
70-86	Tie Rod Boot Kit (2) (Corolla)	19-1712
78-88	Tie Rod Boot Kit (2) Cressida	19-1712
79-86	Tie Rod Boot Kit (2) (Supra)	19-1712

TRACK ARM BUSHINGS, REAR

(Corolla GTS, SR-5) RWD

85-87	Track Arm Bushing Kit	18-1205
-------	-----------------------	---------

TOTAL KITS

<i>(Celica)</i>		
00-05	Total Kit	18-2007
<i>(Corolla GTS, SR-5) RWD</i>		
85-87	Total Kit	18-2010
<i>(MR2)</i>		
85-89	Total Kit	18-2008
91-95	Total Kit	18-2009



Toyota Truck

BODY & CAB MOUNTS

<i>(Pickup, Tacoma 2WD)</i>		
95-00	Body Mount Kit	18-103
<i>(Pickup, Tacoma 4WD)</i>		
79-88	Body Mount Kit	18-101
89-00	Body Mount Kit	18-103
<i>(4Runner 4WD)</i>		
84-88	Body Mount Kit	18-102

BUMP STOPS

<i>(Tacoma, 4Runner 2WD & 4WD)</i>		
96-02	Front Bump Stops (4)	18-1301

COIL SPRING LIFT SPACERS

<i>(Tacoma, 4Runner 2WD & 4WD)</i>		
96-02	Front Coil Spring Lift Kit, 2.5" Lift	18-1701

CONTROL ARM BUSHINGS, FRONT

<i>(Pickup, 2WD)</i>		
79-83	Control Arm Bushing Kit	18-201
84-88	Control Arm Bushing Kit	18-202
89-95	Control Arm Bushing Kit	18-205
<i>(Pickup, 4WD)</i>		
86-88	Control Arm Bushing Kit	18-204
89-95	Control Arm Bushing Kit	18-206
<i>(4Runner, 2WD & 4WD)</i>		
86-88	Control Arm Bushing Kit	18-204
89-95	Control Arm Bushing Kit	18-206

CONTROL ARM BUSHINGS, REAR

<i>(4Runner, 2WD & 4WD)</i>		
90-95	Control Arm Bushing Kit	18-301

SPRING & SHACKLE BUSHINGS, FRONT & REAR

<i>(Landcruiser FJ40 & FJ60 4WD)</i>		
64-80	Front Spring Eye and Shackle Bushing Kit	18-1003
64-80	Rear Spring Eye and Shackle Bushing Kit	18-1003
81-87	Front Spring Eye and Shackle Bushing Kit	18-1007
81-87	Rear Spring Eye and Shackle Bushing Kit	18-1007
<i>(Pickup, 2WD)</i>		
79-83	Rear Spring Eye and Shackle Bushing Kit	18-1001
84-88	Rear Spring Eye and Shackle Bushing Kit	18-1002
89-95	Rear Spring Eye and Shackle Bushing Kit	18-1005
<i>(Pickup, 4WD)</i>		
79-85	Front Spring Eye and Shackle Bushing Kit	18-1004
79-83	Rear Spring Eye and Shackle Bushing Kit	18-1001
84-88	Rear Spring Eye and Shackle Bushing Kit	18-1002
89-99	Rear Spring Eye and Shackle Bushing Kit	18-1006
79-85	Front Frame Shackle Bushing Kit	18-801
79-88	Rear Frame Shackle Bushing Kit	18-802
89-99	Rear Frame Shackle Bushing Kit	18-803



Toyota Truck (Continued)

SPRING & SHACKLE BUSHINGS, FRONT & REAR (Continued)

<i>(4Runner, 4WD)</i>		
84-85	Front Spring Eye and Shackle Bushing Kit	18-1004
84-88	Rear Spring Eye and Shackle Bushing Kit	18-1002
89	Rear Spring Eye and Shackle Bushing Kit	18-1006
<i>(4Runner, 4WD)</i>		
84-85	Front Frame Shackle Bushing Kit	18-801
84-88	Rear Frame Shackle Bushing Kit	18-802

STEERING RACK BUSHINGS

<i>(Tacoma 4WD)</i>		
95-00	Steering Rack Bushing Kit	18-701

STRUT ARM BUSHINGS

<i>(Pickup, 2WD)</i>		
79-95	Strut Arm Bushing Kit	18-1201
<i>(Tacoma 2WD)</i>		
96-01	Strut Arm Bushing Kit	18-1202

SWAY BAR BUSHINGS, FRONT

<i>(Pickup, 2WD)</i>		
79-88	Sway Bar Bushing Kit, 18mm Bar	18-1101
79-95	Sway Bar Bushing Kit, 25mm Bar	18-1102
89-95	Sway Bar Bushing Kit, 23mm Bar	18-1107
<i>(Pickup, 4WD)</i>		
79-88	Sway Bar Bushing Kit, 19mm Bar	18-1103
79-88	Sway Bar Bushing Kit, 23mm Bar	18-1104
89-95	Sway Bar Bushing Kit, 24mm Bar	18-1108
89-95	Sway Bar Bushing Kit, 27mm Bar	18-1111
<i>(Tacoma 2WD & 4WD)</i>		
96-01	Sway Bar Bushing Kit, 25mm Bar	18-1112
96-01	Sway Bar Bushing Kit, 26mm Bar	18-1113
96-01	Sway Bar Bushing Kit, 27mm Bar	18-1114
<i>(Tundra 2WD & 4WD)</i>		
00-01	Sway Bar Bushing Kit, 23mm Bar	18-1117
00-01	Sway Bar Bushing Kit, 24mm Bar	18-1118
<i>(4Runner 2WD & 4WD)</i>		
84-88	Sway Bar Bushing Kit, 19mm Bar	18-1103
84-88	Sway Bar Bushing Kit, 23mm Bar	18-1104
89	Sway Bar Bushing Kit, 24mm Bar	18-1108
89	Sway Bar Bushing Kit, 27mm Bar	18-1111
90-95	Sway Bar Bushing Kit, 24mm Bar	18-1109
96-01	Sway Bar Bushing Kit, 26mm Bar	18-1115
<i>(Landcruiser)</i>		
60-89	Sway Bar Bush. Kit, 22mm Bar (FJ45/55)	18-1105
80-89	Sway Bar Bush. Kit, 23mm Bar (FJ60/62)	18-1106

SWAY BAR BUSHINGS, REAR

<i>(4Runner 4WD)</i>		
90-95	Sway Bar Bushing Kit, 18mm Bar	18-1110
96-01	Sway Bar Bushing Kit, 19mm Bar	18-1116

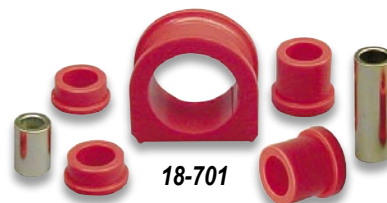

Toyota Truck (Continued)

TORQUE ARM BUSHINGS, FRONT

(Pickup 4WD, 4Runner 4WD)

79-85 Front Axle Torque Arm Bushing Kit 18-1501

TIE ROD BOOTS

79-84 Tie Rod Boot Kit (2) (Pickup, 2WD & 4WD) 19-1712

84-95 Tie Rod Boot Kit (2) (4Runner 2WD & 4WD) 19-1712

60-89 Tie Rod Boot Kit (2) (Landcruiser, All) 19-1712

TOTAL KITS

(Pickup 2WD)

79-83 Total Kit 18-2001

84-88 Total Kit 18-2002

89-94 Total Kit 18-2004

(Pickup 4WD)

79-85 Total Kit 18-2016

86-88 Total Kit 18-2003

89-94 Total Kit 18-2005

(4Runner 4WD)

84-88 Total Kit 18-2006

(Fits Leaf & C-Arm Front Suspensions)

TRIUMPH

CONTROL ARM BUSHINGS

(Stag 2000)

64 & L Rear C-Arm Bushing Kit, 27-46067

(TR5, TR6)

68-75 Front C-Arm Bushing Kit, Lower Inner 27-45096

68-75 Front C-Arm Bushing Kit, Upper Inner 27-45095

68-75 Rear C-Arm Bushing Kit 27-46067

EXHAUST MOUNTS

(Stag 2000)

64 & L Exhaust Bracket Mount kit 27-42060

RADIUS ROD

64 & L Radius Rod Kit (Stag 2000) 27-48070

74 & L Radius Rod Kit (Sprint) 27-43001

STEERING

(Stag 2000)

64 & L Steering Column to Firewall 27-41055

64 & L Rack & Pinion, Rear Mount 27-41038

(Sprint)

74 & L Rack & Pinion, Mount 27-41038

SWAY BAR MOUNTS

(Sprint)

74 & L Sway Bar Mounts 27-42920

SWAY BAR END LINKS, FRONT

(Stag 2000)

64 & L End Link Kit 11-42915



VOLKSWAGEN

CONTROL ARM BUSHINGS, FRONT

<i>(Rabbit, Golf I, Jetta I)</i>		
75-84	Control Arm Bushing Kit	22-201
<i>(Golf II, Jetta II)</i>		
85-92	Control Arm Bushing Kit	22-202
<i>(Golf III, Jetta III)</i>		
93-98	Control Arm Bushing Kit	22-202
<i>(New Beetle, Golf IV, Jetta IV)</i>		
98-06	Control Arm Bushing Kit	22-202

CONTROL ARM BUSHINGS, REAR

<i>(Rabbit, Golf I, Jetta I)</i>		
75-84	Control Arm Bushing Insert Kit	22-301
<i>(Golf II, Jetta II)</i>		
85-92	Control Arm Bushing Insert Kit	22-302
<i>(Golf III, Jetta III)</i>		
93-98	Control Arm Bushing Insert Kit	22-303

MOTOR MOUNTS & INSERTS

<i>(Rabbit, Golf, Jetta, New Beetle)</i>		
75-84	Front Motor Mount Kit	22-501
75-84	Rear Motor (Trans.) Mount Kit	22-502
76-79	Left Motor Mount Insert Kit	22-504
80-84	Left Motor Mount Insert Kit	22-505
85-92	Rear Motor Mount Kit (Golf II, Jetta II)	22-503
98-06	Lower Engine Torque Arm Mount Kit (A4)	22-506

SHOCK TOWER BUSHINGS

<i>(Rabbit, Golf I, Jetta I)</i>		
75-84	Rear Shock Tower Bushing Kit	22-901
<i>(Golf II, Jetta II)</i>		
85-92	Rear Shock Tower Bushing Kit	22-902
<i>(Golf III, Jetta III)</i>		
93-98	Rear Shock Tower Bushing Kit	22-902

STEERING

<i>(Rabbit, Golf I, Jetta I)</i>		
79-84	Rack & Pinion Bushing Kit	22-701
<i>(Golf II, Jetta II)</i>		
85-92	Rack & Pinion Bushing Kit	22-702

STRUT BUSHINGS

<i>(Rabbit, Golf I,II,III Jetta I,II,III)</i>		
75-84	Strut Bushing Kit, Upper Must Use 75-76 Upper Bearing Cap	22-1201
75-98	Strut Adjustable Bump Stop Kit	22-1301

VOLKSWAGEN *(Continued)*

SWAY BAR BUSHINGS, FRONT

<i>(Golf II & III, Jetta II & III)</i>		
85-98	Sway Bar Bushing Kit, 19mm Bar <i>(Golf IV, Jetta IV, New Beetle)</i>	22-1101
98-06	Sway Bar Bushing Kit, 21mm Bar <i>(Above Kits Include End Link Bushings)</i>	22-1102

TOTAL KITS

<i>(Rabbit, Golf I, Jetta I)</i>		
75-84	Total Kit	22-2008
<i>(Golf II, Golf III, Jetta II, Jetta III)</i>		
85-98	Total Kit	22-2009

Identifying Your VW Model

Cabriolet = All convertibles, also called Rabbit
 Rabbit 1975-84 = Known as Golf I outside USA
 Scirocco 1975-81 = Known as Scirocco I
 Scirocco 1982-88 = Known as Scirocco II
 Jetta 1980-84 = Known as Jetta I
 Jetta 1985-92 = Known as Jetta II
 Jetta 1993-98 = Known as Jetta III
 Jetta 1999-05 = Known as Jetta IV
 Golf 1985-92 = Known as Golf II
 Golf 1993-98 = Known as Golf III
 Golf 1999-05 = Known as Golf IV
 A1 Chassis = Rabbit, Scirocco I & II, Jetta I
 A2 Chassis = Golf II, Jetta II, Corrado
 A3 Chassis = Golf III, Jetta III, Cabrio
 A4 Chassis = Golf IV, Jetta IV, New Beetle

Ask Our Sales Department About Our Complete Line Of Available Air-Cooled VW Urethane Products.





SWEAT SHIRTS

These woven 100% soft cotton sweat shirts feature a multi-colored, embroidered logo on the left breast area. Available in sizes Lg, X-L and XX-Lg.

Sweat Shirts

Large Z9503-11 / X-Large Z9503-12
XX-Large Z9503-13

Prothane Polo Shirts

These woven 100% soft cotton polo shirts feature a multi-colored, embroidered logo on the left breast area. Available in black, and come in sizes of Lg-XXLg.

Prothane Polo Shirts

Large Z9515-12
X-Large Z9515-13
XX-Large Z9515-14

T-Shirts

A Large PROTHANE™ logo is silkscreened on the back of this top quality 100% cotton shirt with a similar small logo on the front. Available in Dark or White in sizes M-XXL.

White T-Shirts

White Large Z9510-12
White X-Large Z9510-13
White XX-Large Z9510-14

Dark T-Shirts

Dark Large Z9510-26
Dark X-Large Z9510-27
Dark XX-Large Z9510-28



Prothane Embroidered Caps

The distinctive PROTHANE™ logo is embroidered in con-trasting colors in the front of this premium grade "Sandwich" style Pro Cap. Features adjustable velcro strap. Styles and colors may vary from time to time.

Prothane Embroidered Cap Z9520-20



Banners & Decals

A full line of items are available for in-store or vehicle use. These include a large, colorful wall poster, Authorized Dealer decals and PROTHANE™ die cut vinyl decals which come in a variety of sizes and colors.

Promotional Oval Decal 6 X 1-7/8, 10 Pack	Z9531	Prothane Sponsor Decal 2 X 11 White, Each	Z9532-13
Prothane Decal 1 X 6 Red, Pair	Z9531-13	Prothane Car Decal 6 X 28 Red, Each	Z9533-13
Prothane Decal 1 X 6 White, Pair	Z9531-15	Prothane Car Decal 6 X 28 White, Each	Z9533-15
Prothane Sponsor Decal 2 X 11 Red, Each	Z9532-13	Prothane Performance Team Decal 4 X 46 White, Each	Z9534-15
		Prothane Authorized Dealer Decal	Z9535
		Prothane Wall Poster 12 X 30	Z9553
		Prothane Banner 24 X 60 White	Z9553-11



3560 Cadillac Ave., Costa Mesa, CA 92626 / 714 / 979-4990 • FAX 714 / 979-3468

1-888-PROTHANE

PROTHANE™ is a division of DEE Engineering Inc.

©2006 DEE Engineering Inc.

PART No. Z2007-URE

On Line at www.prothane.com

DISTRIBUTED BY